OpenVMS Alpha Guide to Upgrading Privileged-Code Applications

Order Number: AA-QSBGD-TE

April 2001

Alpha privileged-code applications link against the system base image (SYS\$BASE_IMAGE.EXE) on OpenVMS Alpha. This guide explains the changes that might impact Alpha privileged-code applications as a result of the OpenVMS Alpha 64-bit virtual addressing and kernel threads support provided in OpenVMS Alpha Version 7.0 and later.

Privileged-code applications from versions prior to OpenVMS Alpha Version 7.0 might require the source-code changes described in this guide.

Revision/Update Information: This manual supersedes the *OpenVMS Alpha Guide to Upgrading Privileged-Code Applications*, Version 7.1

Software Version: OpenVMS Alpha Version 7.3

**Compaq Computer Corporation
Houston, Texas**

© 2001 Compaq Computer Corporation

Compaq, VAX, VMS, and the Compaq logo Registered in U.S. Patent and Trademark Office.

OpenVMS is a trademark of Compaq Information Technologies Group, L.P. in the United States and other countries.

All other product names mentioned herein may be trademarks of their respective companies.

Confidential computer software. Valid license from Compaq required for possession, use, or copying. Consistent with FAR 12.211 and 12.212, Commercial Computer Software, Computer Software Documentation, and Technical Data for Commercial Items are licensed to the U.S. Government under vendor's standard commercial license.

Compaq shall not be liable for technical or editorial errors or omissions contained herein. The information in this document is provided "as is" without warranty of any kind and is subject to change without notice. The warranties for Compaq products are set forth in the express limited warranty statements accompanying such products. Nothing herein should be construed as constituting an additional warranty.

ZK6466

The Compaq *OpenVMS* documentation set is available on CD-ROM.

This document was prepared using DECdocument, Version 3.3-1b.

Contents

Preface	ix
1 Introduction	
1.1 Quick Description of OpenVMS Alpha 64-Bit Virtual Addressing	1-1
1.2 Quick Description of OpenVMS Alpha Kernel Threads	1-2
1.3 How to Use This Guide	1-2
Part I Privileged-Code Changes	
2 Upgrading Privileged Software to OpenVMS Alpha Version 7.0	
2.1 Recommendations for Upgrading Privileged-Code Applications	2-1
2.1.1 Summary of Infrastructure Changes	2-1
2.1.2 Changes Not Identified by Warning Messages	2-2
2.2 I/O Changes	2-2
2.2.1 Impact of IRPE Data Structure Changes	2-3
2.2.2 Impact of MMG_STD\$IOLOCK, MMG_STD\$UNLOCK Changes	2-4
2.2.2.1 Direct I/O Functions	2-4
2.2.3 Impact of MMG_STD\$SVAPTECHK Changes	2-7
2.2.4 Impact of PFN Database Entry Changes	2-7
2.2.5 Impact of IRP Changes	2-7
2.3 General Memory Management Infrastructure Changes	2-8
2.3.1 Location of Process Page Tables	2-8
2.3.2 Interpretation of Global and Process Section Table Index	2-8
2.3.3 Location of Process and System Working Set Lists	2-8
2.3.4 Size of a Working Set List Entry	2-9
2.3.5 Location of Page Frame Number (PFN) Database	2-9
2.3.6 Format of PFN Database Entry	2-9
2.3.7 Process Header WSLX and BAK Arrays	2-9
2.3.8 Free S0/S1 System Page Table Entry List	2-10
2.3.9 Location of the Global Page Table	2-10
2.3.10 Free Global Page Table Entry List	2-10
2.3.11 Region Descriptor Entries (RDEs)	2-10
2.4 Kernel Threads Changes	2-10
2.4.1 The CPU\$L_CURKTB Field	2-10
2.4.2 Mutex Locking	2-11
2.4.3 Scheduling Routines	2-11
2.4.4 New MWAIT State	2-11
2.4.5 System Services Dispatching	2-11
2.4.6 Asynchronous System Traps (ASTs)	2-11
2.4.7 TB Invalidation and Macros	2-12
2.4.8 New PCB/KTB Fields	2-13
2.4.9 CTL\$AL_STACK and CTL\$AL_STACKLIM	2-14

2.4.10	Floating-Point Register and Execution Data Blocks (FREDs)	2-14
2.5	Registering Images That Have Version Dependencies	2-14
2.5.1	Version Identification (ID) Number Change to Three Subsystems	2-15

3 Replacements for Removed Privileged Symbols

3.1	Removed Date Structure Fields	3-2
3.2	Removed Routines	3-7
3.3	Removed Macros	3-11
3.3.1	Removed MACRO-32 Macros Formerly in SYS\$LIBRARY:LIB.MLB	3-11
3.3.2	C Header Files Removed From SYS\$LIBRARY:SYS\$LIB_C.TLB.	3-11
3.4	Removed System Data Cells	3-12

Part II Enhancing Privileged-Code Applications

4 Modifying Device Drivers to Support 64-Bit Addressing

4.1	Recommendations for Modifying Device Drivers	4-1
4.2	Mixed Pointer Environment in C	4-1
4.3	\$QIO Support for 64-Bit Addresses	4-2
4.4	Declaring Support for 64-Bit Addresses in Drivers	4-4
4.4.1	Drivers Written in C	4-4
4.4.2	Drivers Written in MACRO-32	4-4
4.4.3	Drivers Written in BLISS	4-5
4.5	I/O Mechanisms	4-5
4.5.1	Simple Buffered I/O	4-6
4.5.2	Direct I/O	4-7
4.5.3	Direct I/O Buffer Map (DIOBM)	4-8
4.5.4	64-Bit AST	4-9
4.5.5	64-Bit ACB Within the IRP	4-10
4.5.6	I/O Function Definitions	4-10
4.6	64-Bit Support in Example Driver	4-12
4.6.1	Example: Declaring 64-Bit Functions	4-12
4.6.2	Example: Declaring 64-Bit Buffered I/O Packet	4-13
4.6.3	Example: Changes to LRSWRITE	4-13
4.6.4	Example: Changes to LRSSETMODE	4-14
4.6.5	Example: Changes to LRSSTARTIO	4-15

5 Modifying User-Written System Services

6 Kernel Threads Process Structure

6.1	Process Control Blocks (PCBs) and Process Headers (PHDs)	6-1
6.1.1	Effect of a Multithreaded Process on the PCB and PHD	6-1
6.2	Kernel Thread Blocks (KTBs)	6-2
6.2.1	KTB Vector	6-2
6.2.2	Floating-Point Registers and Execution Data Blocks (FREDs)	6-3
6.2.3	Kernel Threads Region	6-3
6.2.4	Per-Kernel Thread Stacks	6-3
6.2.5	Per-Kernel Thread Data Cells	6-4
6.2.6	Layout of the Per-Kernel Thread	6-4
6.2.7	Summary of Process Data Structures	6-4

6.3	Process Identifiers (PIDs)	6-5
6.3.1	Multithread Effects on the PID	6-6
6.3.2	Range Checking and Sequence Vectors	6-7
6.4	Process Status Bits	6-8

A Data Structure Changes

A.1	Pointer Size Conventions	A-1
A.2	Buffer Object Descriptor (BOD)	A-2
A.3	Buffered I/O (BUFIO)	A-2
A.4	Complex Chained Buffer (CXB)	A-3
A.5	Data Chain Block (DCBE)	A-4
A.6	Direct I/O Buffer Map (DIOBM)	A-5
A.7	Function Decision Table (FDT)	A-9
A.8	I/O Request Packet (IRP)	A-9
A.9	I/O Request Packet Extension (IRPE)	A-12
A.10	Process Header (PHD)	A-14
A.11	SCSI-2 Diagnose Buffer (S2DGB)	A-15
A.12	VMS Communications Request Packet (VCRP)	A-15

B I/O Support Routine Changes

B.1	ACP_STD\$READBLK and ACP_STD\$WRITEBLK	B-1
B.2	EXE_STD\$ALLOC_BUFIO_32, EXE_STD\$ALLOC_BUFIO_64	B-1
B.3	EXE_STD\$ALLOC_DIAGBUF	B-2
B.4	EXE_STD\$LOCK_ERR_CLEANUP	B-3
B.5	EXE_STD\$MODIFY, EXE_STD\$READ, EXE_STD\$WRITE	B-4
B.6	EXE_STD\$MODIFYLOCK, EXE_STD\$READLOCK, EXE_STD\$WRITELOCK	B-5
B.6.1	CALL_xLOCK and CALL_xLOCK_ERR Macros	B-6
B.7	EXE_STD\$READCHK and EXE_STD\$WRITECHK	B-6
B.7.1	CALL_xCHK and CALL_xCHKR Macros	B-6
B.8	EXE_STD\$SETCHAR and EXE_STD\$SETMODE	B-6
B.9	IOC_STD\$CREATE_DIOBM	B-7
B.10	IOC_STD\$FILL_DIOBM	B-8
B.11	IOC_STD\$PTETOPFN	B-9
B.12	IOC_STD\$RELEASE_DIOBM	B-10
B.13	IOC_STD\$SIMREQCOM, IOC\$SIMREQCOM	B-10
B.13.1	CALL_SIMREQCOM Macro	B-11
B.13.2	IOC\$SIMREQCOM	B-11
B.14	IOC_STD\$SVAPTE_IN_BUF	B-11
B.15	IOC_STD\$VA_TO_PA	B-12
B.16	MMG_STD\$GET_PTE_FOR_VA	B-12
B.17	MMG_STD\$IOLOCK, MMG\$IOLOCK, MMG_STD\$IOLOCK_BUF	B-14
B.17.1	CALL_IOLOCK Macro	B-15
B.18	MMG_STD\$UNLOCK, MMG\$UNLOCK, MMG_STD\$IOUNLOCK_BUF	B-16
B.18.1	CALL_UNLOCK Macro	B-16
B.19	MMG_STD\$SVAPTECHK, MMG\$SVAPTECHK	B-17

C Kernel Threads Routines and Macros

EXESCVT_IPID_TO_KTB Routine	C-1
EXESCVT_EPID_TO_KTB Routine	C-2
GET_CURKTB Macro	C-3
CVT_IPID_TO_PCB_KTB Macro	C-4
CVT_IPID_TO_KTB Macro	C-5

Index

Examples

5-1	Creating a Privileged Library Vector (PLV) for C on Alpha Systems	5-3
-----	---	-----

Figures

4-1	32-Bit Buffered I/O Packet Header	4-6
4-2	New 64-Bit Buffered I/O Packet Header	4-6
4-3	Direct I/O Buffer Map Data Structure	4-8
4-4	64-Bit AST	4-9
4-5	Embedded ACB64	4-10
6-1	Default Kernel Stack and User Stack Sizes	6-4
6-2	Structure of a Multithreaded Process	6-5
6-3	Process ID (PID)	6-6
6-4	Extended Process ID (EPID)	6-6
6-5	Range Checking and Sequence Vectors	6-7

Tables

2-1	Arguments for TBI_DATA_64 and TBI_SINGLE	2-12
2-2	Arguments for TBI_ALL	2-13
2-3	New PCB/KTB Fields	2-13
2-4	Stack Arrays	2-14
3-1	Removed Date Structure Fields	3-2
3-2	Removed Routines	3-7
3-3	Removed System Data Cells	3-12
4-1	\$QIO[W] Argument Changes	4-2
4-2	Summary of 64-Bit Support by I/O Mechanism	4-5
4-3	Guidelines for 64-Bit Support by I/O Function	4-11
5-1	Components of the Alpha Privileged Library Vector	5-2
5-2	Flags for 64-Bit User-Written Services	5-3
A-1	64-Bit Pointer Data Types	A-1
A-2	BOD Structure Changes	A-2
A-3	BUFIO Packet	A-3
A-4	CXB Structure Changes	A-4
A-5	DCBE Structure Changes	A-5
A-6	Primary DIOBM Structure	A-6

A-7	Secondary DIOBM Structure	A-8
A-8	FDT Structure Changes	A-9
A-9	IRP Changes	A-10
A-10	IRPE Changes	A-13
A-11	PHD Structure Changes	A-15
A-12	VCRP Structure Changes	A-15
B-1	EXE_STD\$ALLOC_BUFIO_32, EXE_STD\$ALLOC_BUFIO_64 Arguments	B-1
B-2	EXE_STD\$ALLOC_BUFIO_32, EXE_STD\$ALLOC_BUFIO_64 Implicit Outputs	B-2
B-3	EXE_STD\$ALLOC_DIAGBUF Arguments	B-3
B-4	EXE_STD\$ALLOC_DIAGBUF Implicit Outputs	B-3
B-5	EXE_STD\$LOCK_ERR_CLEANUP Arguments	B-4
B-6	EXE_STD\$LOCK_ERR_CLEANUP Implicit Inputs and Outputs	B-4
B-7	IOC_STD\$CREATE_DIOBM Arguments	B-7
B-8	IOC_STD\$FILL_DIOBM Arguments	B-8
B-9	IOC_STD\$RELEASE_DIOBM Arguments	B-10
B-10	IOC_STD\$SVAPTE_IN_BUF Arguments	B-11
B-11	IOC_STD\$SVAPTE_IN_BUF Implicit Inputs	B-12
B-12	IOC_STD\$VA_TO_PA Arguments	B-12
B-13	MMG_STD\$GET_PTE_FOR_VA Arguments	B-13
B-14	MMG_STD\$IOLOCK_BUF Arguments	B-14

Preface

Alpha privileged-code applications link against the system base image (SYSSBASE_IMAGE.EXE) on OpenVMS Alpha. This guide explains the changes that might impact Alpha privileged-code applications as a result of the OpenVMS Alpha 64-bit virtual addressing and kernel threads support provided in OpenVMS Alpha Version 7.0.

This guide is intended to help developers using privileged-code interfaces understand how the changes in OpenVMS Alpha Version 7.0 might affect their applications and device drivers.

Nonprivileged code applications should not require any source code changes and should run without modification on OpenVMS Alpha Versions 7.0 and 7.1.

The information in this document applies only to privileged-code applications on OpenVMS Alpha systems; applications on OpenVMS VAX systems are not affected.

OpenVMS Alpha Version 7.3 Note

Privileged-code applications and device drivers that were recompiled and relinked to run on OpenVMS Alpha Version 7.0 do not require source-code changes and do not have to be recompiled and relinked to run on OpenVMS Alpha Version 7.3.

However, privileged-code applications from releases prior to OpenVMS Alpha Version 7.0 that were not recompiled and relinked for OpenVMS Alpha Version 7.0, might need to be recompiled and relinked to run on OpenVMS Alpha Version 7.3 and might require source-code changes as described in this guide.

For more information about recompiling and relinking privileged-code applications and device drivers for OpenVMS Alpha Version 7.3, see *OpenVMS Version 7.1 Release Notes*.

Intended Audience

This guide is intended for system programmers who use privileged-mode interfaces in their applications.

Document Structure

The guide is divided into three parts:

- Part I describes the infrastructure changes that might affect privileged-code applications and provides guidelines for upgrading them to OpenVMS Alpha Version 7.0.

- Part II describes the changes that can be made to customer-written system services and device drivers to support 64-bit addresses and kernel threads.
- The appendixes contain descriptions of I/O routines, I/O data structures, kernel threads routines, and kernel threads macros.

For more information about how to use this guide, see Chapter 1.

Related Documents

- *OpenVMS Alpha Guide to 64-Bit Addressing and VLM Features*¹
- *OpenVMS Programming Concepts Manual*
- *OpenVMS Record Management Services Reference Manual*
- *OpenVMS System Services Reference Manual: A-GETUAI and OpenVMS System Services Reference Manual: GETUTC-Z*

For additional information about Compaq *OpenVMS* products and services, access the following World Wide Web address:

<http://www.openvms.compaq.com/>

Reader's Comments

Compaq welcomes your comments on this manual. Please send comments to either of the following addresses:

Internet	openvmsdoc@compaq.com
Mail	Compaq Computer Corporation OSSG Documentation Group, ZKO3-4/U08 110 Spit Brook Rd. Nashua, NH 03062-2698

How to Order Additional Documentation

Use the following World Wide Web address to order additional documentation:

<http://www.openvms.compaq.com/>

If you need help deciding which documentation best meets your needs, call 800-282-6672.

Conventions

The following conventions are used in this manual:

Ctrl/ <i>x</i>	A sequence such as Ctrl/ <i>x</i> indicates that you must hold down the key labeled Ctrl while you press another key or a pointing device button.
PF1 <i>x</i>	A sequence such as PF1 <i>x</i> indicates that you must first press and release the key labeled PF1 and then press and release another key or a pointing device button.

¹ This manual has been archived but is available on the OpenVMS Documentation CD-ROM. This information has also been included in the *OpenVMS Programming Concepts Manual, Volume I*.

<code>Return</code>	In examples, a key name enclosed in a box indicates that you press a key on the keyboard. (In text, a key name is not enclosed in a box.)
	In the HTML version of this document, this convention appears as brackets, rather than a box.
<code>...</code>	A horizontal ellipsis in examples indicates one of the following possibilities: <ul style="list-style-type: none"> • Additional optional arguments in a statement have been omitted. • The preceding item or items can be repeated one or more times. • Additional parameters, values, or other information can be entered.
<code>. . . .</code>	A vertical ellipsis indicates the omission of items from a code example or command format; the items are omitted because they are not important to the topic being discussed.
<code>()</code>	In command format descriptions, parentheses indicate that you must enclose choices in parentheses if you specify more than one.
<code>[]</code>	In command format descriptions, brackets indicate optional choices. You can choose one or more items or no items. Do not type the brackets on the command line. However, you must include the brackets in the syntax for OpenVMS directory specifications and for a substring specification in an assignment statement.
<code> </code>	In command format descriptions, vertical bars separate choices within brackets or braces. Within brackets, the choices are optional; within braces, at least one choice is required. Do not type the vertical bars on the command line.
<code>{ }</code>	In command format descriptions, braces indicate required choices; you must choose at least one of the items listed. Do not type the braces on the command line.
bold text	This typeface represents the introduction of a new term. It also represents the name of an argument, an attribute, or a reason.
<i>italic text</i>	Italic text indicates important information, complete titles of manuals, or variables. Variables include information that varies in system output (Internal error <i>number</i>), in command lines (<i>/PRÓDUCER=name</i>), and in command parameters in text (where <i>dd</i> represents the predefined code for the device type).
UPPERCASE TEXT	Uppercase text indicates a command, the name of a routine, the name of a file, or the abbreviation for a system privilege.
Monospace text	Monospace type indicates code examples and interactive screen displays. <p>In the C programming language, monospace type in text identifies the following elements: keywords, the names of independently compiled external functions and files, syntax summaries, and references to variables or identifiers introduced in an example.</p>
<code>-</code>	A hyphen at the end of a command format description, command line, or code line indicates that the command or statement continues on the following line.

numbers

All numbers in text are assumed to be decimal unless otherwise noted. Nondecimal radices—binary, octal, or hexadecimal—are explicitly indicated.

Introduction

OpenVMS Alpha Version 7.0 includes significant changes to OpenVMS Alpha privileged interfaces and data structures, mostly as a result of support for 64-bit virtual addresses and kernel threads.

For 64-bit virtual addresses, these changes are part of the infrastructure work needed to enable processes to grow their virtual address space beyond the existing 1 GB limit of P0 space and the 1 GB limit of P1 space to include P2 space, making a total of 8TB. Likewise, S2 is the extension of system space.

Kernel threads support causes significant changes to the process structure within OpenVMS (most notably to the process control block (PCB)). Although kernel threads support does not explicitly change any application programming interfaces (APIs) within OpenVMS, it does change the use of the PCB in such a way that some existing privileged code may be impacted.

As a result of these changes, some privileged-code applications might need to make source-code changes to run on OpenVMS Alpha Version 7.0 and later.

This chapter briefly describes OpenVMS Alpha Version 7.0 64-bit virtual address and kernel threads support and suggests how you should use this guide to ensure that your privileged-code application runs successfully on OpenVMS Alpha Version 7.0 and later.

1.1 Quick Description of OpenVMS Alpha 64-Bit Virtual Addressing

OpenVMS Alpha Version 7.0 provides support for 64-bit virtual addresses, which makes more of the 64-bit virtual address space defined by the Alpha architecture available to the OpenVMS Alpha operating system and to application programs. The 64-bit address features allow processes to map and access data beyond the previous limits of 32-bit virtual addresses. Both process-private and system virtual address space now extend to 8 TB.

In addition to the dramatic increase in virtual address space, OpenVMS Alpha 7.0 significantly increases the amount of physical memory that can be used by individual processes.

Many tools and languages supported by OpenVMS Alpha (including the Debugger, run-time library routines, and DEC C) are enhanced to support 64-bit virtual addressing. Input and output operations can be performed directly to and from the 64-bit addressable space by means of RMS services, the \$QIO system service, and most of the device drivers supplied with OpenVMS Alpha systems.

Underlying this are new system services that allow an application to allocate and manage the 64-bit virtual address space that is available for process-private use.

Introduction

1.1 Quick Description of OpenVMS Alpha 64-Bit Virtual Addressing

For more information about OpenVMS Alpha 64-bit virtual address features, see the *OpenVMS Alpha Guide to 64-Bit Addressing and VLM Features*¹.

1.2 Quick Description of OpenVMS Alpha Kernel Threads

OpenVMS Alpha Version 7.0 provides kernel threads features, which extend process scheduling capabilities to allow threads of a process to run concurrently on multiple CPUs in a multiprocessor system. The only interface to kernel threads is through the DECthreads package. Existing threaded code that uses either the CMA API or the POSIX threads API should run without change and gain the advantages provided by the kernel threads project.

Kernel threads allows a multithreaded process to execute code flows independently on more than one CPU at a time. This allows a threaded application to make better use of multiple CPUs in an SMP system. DECthreads uses these independent execution contexts as virtual CPUs and schedules application threads on them. OpenVMS then schedules the execution contexts (kernel threads) onto physical CPUs. By providing a callback mechanism from the OpenVMS scheduler to the DECthreads thread scheduler, scheduling latencies inherent in user-mode-only thread managers is greatly reduced. OpenVMS informs DECthreads when a thread has blocked in the kernel. Using this information, DECthreads can then opt to schedule some other ready thread.

For more information about kernel threads, refer to the Bookreader version of the *OpenVMS Programming Concepts Manual* and Chapter 6 in this guide.

1.3 How to Use This Guide

Read Part I to learn about the changes that might be required for privileged-code applications to run on OpenVMS Alpha Version 7.0.

Refer to Part II for information about enhancing customer-written system services and device drivers with OpenVMS Version 7.0 features.

Refer to the Appendixes for more information about some of the data structures and routines mentioned throughout this guide.

¹ This manual has been archived but is available on the OpenVMS Documentation CD-ROM. This information has also been included in the *OpenVMS Programming Concepts Manual, Volume I*.

Part I

Privileged-Code Changes

Upgrading Privileged Software to OpenVMS Alpha Version 7.0

The new features provided in OpenVMS Alpha Version 7.0 have required corresponding changes in internal system interfaces and data structures. These internal changes might require changes in some privileged software.

This chapter contains recommendations for upgrading privileged-code applications to ensure that they run on OpenVMS Alpha Version 7.0. Once your application is running on OpenVMS Alpha Version 7.0, you can enhance it as described in Part II.

2.1 Recommendations for Upgrading Privileged-Code Applications

To ensure that a privileged-code application runs on OpenVMS Alpha Version 7.0, do the following:

1. Recompile and relink your application to identify almost all of the places where source changes will be necessary. Some changes can be identified by inspection.
2. If you encounter compile-time or link-time warnings or errors, you must make the source-code changes required to resolve them.
See Section 2.1.1 for descriptions of the infrastructure changes that can affect your applications and more information about how to handle them.
3. Refer to Chapter 3 for information about the data structure fields, routines, macros, and system data cells obviated by OpenVMS Alpha Version 7.0 that might affect privileged-code applications.
4. Once your application recompiles and relinks without errors, you can enhance it to take advantage of the OpenVMS Alpha Version 7.0 features described in Part II.

2.1.1 Summary of Infrastructure Changes

This section summarizes OpenVMS Alpha Version 7.0 changes to the kernel that may require source changes in customer-written drivers and inner-mode software. The recommendations in bold face type indicate how each change can be handled.

- Page tables have moved from the balance set slots to page table space. **(Compile and link the application.)**
- The global page table has moved from S0/S1 space to S2 space. **(Compile and link the application.)**
- The PFN database has moved from S0/S1 space to S2 space. **(Compile C applications. Inspect MACRO applications for changes that might not cause warning messages. Link all applications.)**

Upgrading Privileged Software to OpenVMS Alpha Version 7.0

2.1 Recommendations for Upgrading Privileged-Code Applications

- PFN database entry format has changed. (**Compile and link the application.**)
- Routines MMG\$IOLOCK and MMG\$UNLOCK are obsolete and are replaced by MMG_STD\$IOLOCK_BUF and DIOBM. (**Compile and link the application.**)
- A buffer locked for direct I/O is now described by SVAPTE, BOFF, BCNT, and a DIOBM.
Be aware of code that clears IRP\$L_SVAPTE to keep a buffer locked even after the IRP is reused or deleted. (**Inspect the code for changes.**)
- A single IRPE can only be used to lock down a single region of pages. (**Compile and link the application.**)
- Some assumptions about I/O structure field adjacencies may no longer be true; for example, IRP\$L_QIO_P1 and IRP\$L_QIO_P2 are now more than 4 bytes apart. (**Compile, link, inspect the code.**)
- The IRP\$L_AST, IRP\$L_ASTPRM, and IRP\$L_IOSB cells have been removed. (**Compile and link the application.**)
- Two types of ACBs; an IRP is always in ACB64 format. (**Compile, link, inspect the code.**)
- MMG\$SVAPTECHK can longer be used for P0/P1 addresses. In addition, P2/S2 are not allowed; only S0/S1 are supported. (**Inspect the code.**)
- Two types of buffer objects; buffer objects can be mapped into S2 space. (**Inspect the code.**)

The remaining sections in this chapter contain more details about these changes.

Important

All device drivers, VCI clients, and inner-mode components must be recompiled and relinked to run on OpenVMS Alpha Version 7.0.

2.1.2 Changes Not Identified by Warning Messages

A few necessary source changes might not always be immediately identified by compile-time or link-time warnings. Some of these are:

- Pointers to a PFN database entry are now 64-bits wide. If you save or restore them, you must preserve the full 64 bits of these pointers.
- The MMG[_STD]\$SVAPTECHK routine can handle only S0/S1 addresses. If you pass it an address in any other space, such as P0, it will declare a bugcheck.
- The various SCH\$ routines that put a process (now kernel thread) into a wait state now require the KTB instead of the PCB. (This is not a 64-bit change, but it could affect drivers OpenVMS Alpha Version 7.0 device drivers.)

2.2 I/O Changes

This section describes OpenVMS Alpha Version 7.0 changes to the I/O subsystem that might require source changes to device drivers.

2.2.1 Impact of IRPE Data Structure Changes

As described in Section A.9, the I/O Request Packet Extension (IRPE) structure now manages a single additional locked-down buffer instead of two. The general approach to deal with this change is to use a chain of additional IRPE structures.

Current users of the IRPE may be depending on the fact that a buffer locked for direct I/O could be fully described by the `irp$l_svapte`, `irp$l_boff`, and `irp$l_bcmt` values. For example, it is not uncommon for an IRPE to be used in this fashion:

1. The second buffer that will be eventually associated with the IRPE is locked first by calling `EXE_STD$READLOCK` with the IRP.
2. The `irp$l_svapte`, `irp$l_boff`, and `irp$l_bcmt` values are copied from the IRP into the IRPE. The `irp$l_svapte` cell is then cleared. The locked region is now completely described by the IRPE.
3. The first buffer is locked by calling `EXE_STD$READLOCK` with the IRP again.
4. A driver-specific error callback routine is required for the `EXE_STD$READLOCK` calls. This error routine calls `MMG_STD$UNLOCK` to unlock any region associated with the IRP and deallocates the IRPE.

This approach no longer works correctly. As described in Appendix A, the `DIOBM` structure that is embedded in the IRP will be needed as well. Moreover, it may not be sufficient to simply copy the `DIOBM` from the IRP to the IRPE. In particular, the `irp$l_svapte` may need to be modified if the `DIOBM` is moved.

The general approach to this change is to lock the buffer using the IRPE directly. This approach is shown in some detail in the following example:

```
irpe->irpe$b_type = DYN$C_IRPE;      ❶
irpe->irpe$l_driver_p0 = (int) irp;   ❷

status = exe_std$readlock( irp, pcb, ucb, ccb,      ❸
                          buf1, buf1_len, lock_err_rtn ❹ );
if( !$VMS_STATUS_SUCCESS(status) ) return status;

irpe->irpe$b_rmod = irp->irp$b_rmod; ❺
status = exe_std$readlock( (IRP *)irpe, pcb, ucb, ccb, ❻
                          buf2, buf2_len, lock_err_rtn );
if( !$VMS_STATUS_SUCCESS(status) ) return status;
```

- ❶ The IRPE needs to be explicitly identified as an IRPE because the error callback routine depends on being able to distinguish an IRP from an IRPE.
- ❷ The IRPE needs to contain a pointer to the original IRP for this I/O request for potential use by the error callback routine. Here, a driver-specific cell in the IRPE is used.
- ❸ The first buffer is locked using the IRP.
- ❹ If `EXE_STD$READLOCK` cannot lock the entire buffer into memory, the following occurs:
 - a. The error callback routine, `LOCK_ERR_RTN`, is invoked.
 - b. Depending on the error status, either the I/O is aborted or backed out for automatic retry. In any event, the IRP is deallocated.
 - c. `EXE_STD$READLOCK` returns the `SS$FDT_COMPL` warning status.

Upgrading Privileged Software to OpenVMS Alpha Version 7.0

2.2 I/O Changes

- ⑤ The caller's access mode must be copied into the IRPE in preparation for locking the second buffer using the IRPE.
- ⑥ The second buffer is locked using the IRPE. If this fails, the error callback routine LOCK_ERR_RTN is called with the IRPE.

This approach is easily generalized to more buffers and IRPEs. The only thing omitted from this example is the code that allocates and links together the IRPEs. The following example shows the associated error callback routine in its entirety; it can handle an arbitrary number of IRPEs.

```
void lock_err_rtn (IRP *const lock_irp, ①
                  PCB *const pcb, UCB *const ucb, CCB *const ccb,
                  const int errsts,
                  IRP **real_irp_p ② )
{
    IRP *irp;
    if( lock_irp->irp$b_type == DYN$C_IRPE )
        irp = (IRP *) ((IRPE *)lock_irp)->irpe$l_driver_p0; ③
    else
        irp = lock_irp;
    exe_std$lock_err_cleanup (irp); ④
    *real_irp_p = irp; ⑤
    return;
}
```

- ① The lock_irp parameter can be either an IRP or an IRPE, depending on the data structure that was used with EXE_STD\$READLOCK.
- ② Before returning from this error callback routine, you must provide the original IRP via the real_irp_p parameter so that the I/O can be properly terminated.
- ③ If this routine has been passed an IRPE, a pointer to the original IRP from the irpe\$l_driver_p0 cell is obtained because it was explicitly placed there.
- ④ The new EXE_STD\$LOCK_ERR_CLEANUP routine does all the needed unlocking and deallocation of IRPEs.
- ⑤ Provide the address of the original IRP to the caller.

2.2.2 Impact of MMG_STD\$IOLOCK, MMG_STD\$UNLOCK Changes

The interface changes to the MMG_STD\$IOLOCK and MMG_STD\$UNLOCK routines are described in Appendix B. The general approach to these changes is to use the corresponding replacement routines and the new DIOBM structure.

2.2.2.1 Direct I/O Functions

OpenVMS device drivers that perform data transfers using direct I/O functions do so by locking the buffer into memory while still in process context, that is, in a driver FDT routine. The PTE address of the first page that maps the buffer is obtained and the byte offset within the page to the start of the buffer is computed. These values are saved in the IRP (irp\$l_svapte and irp\$l_boff). The rest of the driver then uses values in the irp\$l_svapte and irp\$l_boff cells and the byte count in irp\$l_bcmt in order to perform the transfer. Eventually when the transfer has completed and the request returns to process context for I/O postprocessing, the buffer is unlocked using the irp\$l_svapte value and not the original process buffer address.

Upgrading Privileged Software to OpenVMS Alpha Version 7.0 2.2 I/O Changes

To support 64-bit addresses on a direct I/O function, one only needs to ensure the proper handling of the buffer address within the FDT routine.

Almost all device drivers that perform data transfers via a direct I/O function use OpenVMS-supplied FDT support routines to lock the buffer into memory. Because these routines obtain the buffer address either indirectly from the IRP or directly from a parameter that is passed by value, the interfaces for these routines can easily be enhanced to support 64-bit wide addresses.

However, various OpenVMS Alpha memory management infrastructure changes made to support 64-bit addressing have a potentially major impact on the use of the 32-bit `irp$l_svappte` cell by device drivers prior to OpenVMS Alpha Version 7.0. In general, there are two problems:

1. It takes a full 64-bits to address a process PTE in page table space, and,
2. The 64-bit page table space address for a process PTE is only valid when in the context of that process. (This is also known as the "cross-process PTE problem.")

In most cases, both of these PTE access problems are solved by copying the PTEs that map the buffer into nonpaged pool and setting `irp$l_svappte` to point to the copies. This copy is done immediately after the buffer has been successfully locked. A copy of the PTE values is acceptable because device drivers only read the PTE values and are not allowed to modify them. These PTE copies are held in a new nonpaged pool data structure, the **Direct I/O Buffer Map (DIOBM)** structure. A standard DIOBM structure (also known as a fixed-size primary DIOBM) contains enough room for a vector of 9 (`DIOBM$K_PTECNT_FIX`) PTE values. This is sufficient for a buffer size up to 64K bytes on a system with 8 KB pages.¹ It is expected that most I/O requests are handled by this mechanism and that the overhead to copy a small number of PTEs is acceptable, especially given that these PTEs have been recently accessed to lock the pages.

The standard IRP contains an embedded fixed-size DIOBM structure. When the PTEs that map a buffer fit into the embedded DIOBM, the `irp$l_svappte` cell is set to point to the start of the PTE copy vector within the embedded DIOBM structure in that IRP.

If the buffer requires more than 9 PTEs, then a separate "secondary" DIOBM structure that is variably-sized is allocated to hold the PTE copies. If such a secondary DIOBM structure is needed, it is pointed to by the original, or "primary" DIOBM structure. The secondary DIOBM structure is deallocated during I/O postprocessing when the buffer pages are unlocked. In this case, the `irp$l_svappte` cell is set to point into the PTE vector in the secondary DIOBM structure. The secondary DIOBM requires only 8 bytes of nonpaged pool for each page in the buffer. The allocation of the secondary DIOBM structure is not charged against the process BYTLM quota, but it is controlled by the process direct I/O limit (DIOLM). This is the same approach used for other internal data structures that are required to support the I/O, including the kernel process block, kernel process stack, and the IRP itself.

However, as the size of the buffer increases, the run-time overhead to copy the PTEs into the DIOBM becomes noticeable. At some point it becomes less expensive to create a temporary window in S0/S1 space to the process PTEs that map the buffer. The PTE window method has a fixed cost, but the cost is

¹ Eight PTEs are sufficient only if the buffer begins exactly on a page boundary, otherwise a 9th is required.

Upgrading Privileged Software to OpenVMS Alpha Version 7.0

2.2 I/O Changes

relatively high because it requires PTE allocation and TB invalidates. For this reason, the PTE window method is not used for moderately sized buffers.

The transition point from the PTE copy method with a secondary DIOBM to the PTE window method is determined by a new system data cell, `ioc$gl_diobm_ptecnt_max`, which contains the maximum desirable PTE count for a secondary DIOBM. The PTE window method will be used if the buffer is mapped by more than `ioc$gl_diobm_ptecnt_max` PTEs.

When a PTE window is used, `irp$l_svapte` is set to the S0/S1 virtual address in the allocated PTE window that points to the first PTE that maps the buffer. This S0/S1 address is computed by taking the S0/S1 address that is mapped by the first PTE allocated for the window and adding the byte offset within page of the first buffer PTE address in page table space. A PTE window created this way is removed during I/O postprocessing.

The PTE window method is also used if the attempt to allocate the required secondary DIOBM structure fails due to insufficient contiguous nonpaged pool. With an 8 Kb page size, the PTE window requires a set of contiguous system page table entries equal to the number of 8 Mb regions in the buffer plus 1. Failure to create a PTE window as a result of insufficient SPTs is unusual. However, in the unlikely event of such a failure, if the process has not disabled resource wait mode, the \$QIO request is backed out and the requesting process is put into a resource wait state for nonpaged pool (`RSN$NPDYNMEM`). When the process is resumed, the I/O request is retried. If the process has disabled resource wait mode, a failure to allocate the PTE window results in the failure of the I/O request.

When the PTE window method is used, the level-3 process page table pages that contain the PTEs that map the user buffer are locked into memory as well. However, these level-3 page table pages are not locked when the PTEs are copied into nonpaged pool or when the SPT window is used.

The new `IOC_STDS$FILL_DIOBM` routine is used to set `irp$l_svapte` by one of the previously described three methods. The OpenVMS-supplied FDT support routines `EXE_STD$MODIFYLOCK`, `EXE_STD$READLOCK`, and `EXE_STD$WRITELOCK` use the `IOC_STDS$FILL_DIOBM` routine in the following way:

1. The buffer is locked into memory by calling the new `MMG_STD$IOLOCK_BUF` routine. This routine returns a 64-bit pointer to the PTEs and replaces the obsolete `MMG_STD$IOLOCK` routine.

```
status = mmg_std$iolock_buf (buf_ptr, bufsiz, is_read, pcb, &irp->irp$pg_vapte,  
                           &irp->irp$ps_fdt_context->fdt_context$q_qio_rl_value);
```

For more information about this routine, see Section B.17.

2. A value for the 32-bit `irp$l_svapte` cell is derived by calling the new `IOC_STDS$FILL_DIOBM` routine with a pointer to the embedded DIOBM in the IRP, the 64-bit pointer to the PTEs that was returned by `MMG_STD$IOLOCK_BUF`, and the address of the `irp$l_svapte` cell.²

```
status = ioc_std$fill_diobm (&irp->irp$r_diobm, irp->irp$pg_vapte, pte_count,  
                           DIOBM$M_NORESWAIT, &irp->irp$l_svapte);
```

The DIOBM structure is fully described in Section A.6 and this routine is described in Section B.10.

² For performance reasons, the common case that can be handled by the PTE vector in the embedded DIOBM may be duplicated in line to avoid the routine call.

Upgrading Privileged Software to OpenVMS Alpha Version 7.0

2.2 I/O Changes

Device drivers that call MMG_STDSIOLOCK directly will need to examine their use of the returned values and might need to call the IOC_STD\$FILL_DIOBM routine.

2.2.3 Impact of MMG_STD\$SVAPTECHK Changes

Prior to OpenVMS Alpha Version 7.0, the MMG_STD\$SVAPTECHK and MMG\$SVAPTECHK routines compute a 32-bit svapte for either a process or system space address. As of OpenVMS Alpha Version 7.0, these routines are restricted to an S0/S1 system space address and no longer accept an address in P0/P1 space. The MMG_STD\$SVAPTECHK and MMG\$SVAPTECHK routines declare a bugcheck for an input address in P0/P1 space. These routines return a 32-bit system virtual address through the SPT window for an input address in S0/S1 space.

The MMG_STD\$SVAPTECHK and MMG\$SVAPTECHK routines are used by a number of OpenVMS Alpha device drivers and privileged components. In most instances, no source changes are required because the input address is in nonpaged pool.

The 64-bit process-private virtual address of the level 3 PTE that maps a P0/P1 virtual address can be obtained using the new PTE_VA macro. Unfortunately, this macro is not a general solution because it does not address the cross-process PTE access problem. Therefore, the necessary source changes depend on the manner in which the svapte output from MMG_STD\$SVAPTECHK is used.

The INIT_CRAM routine uses the MMG\$SVAPTECHK routine in its computation of the physical address of the hardware I/O mailbox structure within a CRAM that is in P0/P1 space. If you need to obtain a physical address, use the new IOC_STD\$VA_TO_PA routine.

If you call MMG\$SVAPTECHK and IOC\$SVAPTE_TO_PA, use the new IOC_STD\$VA_TO_PA routine instead.

The PTE address in dcb\$l_svapte must be expressible using 32 bits and must be valid regardless of process context. Fortunately, the caller's address is within the buffer that was locked down earlier in the CONV_TO_DIO routine via a call to EXE_STD\$WRITELOCK and the EXE_STD\$WRITELOCK routine derived a value for the irp\$l_svapte cell using the DIOBM in the IRP. Therefore, instead of calling the MMG\$SVAPTECHK routine, the BUILD_DCB routine has been changed to call the new routine EXE_STD\$SVAPTE_IN_BUF, which computes a value for the dcb\$l_svapte cell based on the caller's address, the original buffer address in the irp\$l_qio_p1 cell, and the address in the irp\$l_svapte cell.

2.2.4 Impact of PFN Database Entry Changes

There are changes to the use of the PFN database entry cells containing the page reference count and back link pointer.

For more information, see Section 2.3.6.

2.2.5 Impact of IRP Changes

All source code references to the irp\$l_ast, irp\$l_astprm, and irp\$l_iosb cells have been changed. These IRP cells were removed and replaced by new cells.

For more information, see Appendix A.

Upgrading Privileged Software to OpenVMS Alpha Version 7.0

2.3 General Memory Management Infrastructure Changes

2.3 General Memory Management Infrastructure Changes

This section describes OpenVMS Alpha Version 7.0 changes to the memory management subsystem that might affect privileged-code applications.

For complete information about OpenVMS Alpha support for 64-bit addresses, see the *OpenVMS Alpha Guide to 64-Bit Addressing and VLM Features*.³

2.3.1 Location of Process Page Tables

The process page tables no longer reside in the balance slot. Each process references its own page tables within page table space using 64-bit pointers.

Three macros (located in VMS_MACROS.H in SYSSLIBRARY:SYSSLIB_C.TLB) are available to obtain the address of a PTE in Page Table Space:

- PTE_VA — Returns level 3 PTE address of input VA
- L2PTE_VA — Returns level 2 PTE address of input VA
- L1PTE_VA — Returns level 1 PTE address of input VA

Two macros (located in SYSSLIBRARY:LIB.MLB) are available to map and unmap a PTE in another process's page table space:

- MAP_PTE — Returns address PTE through system space window.
- UNMAP_PTE — Clears mapping of PTE through system space window.

Note that use of MAP_PTE and UNMAP_PTE requires the caller to hold the MMG spinlock across the use of these macros and that UNMAP_PTE must be invoked before another MAP_PTE can be issued.

2.3.2 Interpretation of Global and Process Section Table Index

As of OpenVMS Alpha Version 7.0, the global and process section table indexes, stored primarily in the PHD and PTEs, have different meanings. The section table index is now a positive index into the array of section table entries found in the process section table or in the global section table. The first section table index in both tables is now 1.

To obtain the address of a given section table entry, do the following:

1. Add the PHD address to the value in PHD\$PST_BASE_OFFSET.
2. Multiply the section table index by SEC\$C_LENGTH.
3. Subtract the result of Step 2 from the result of Step 1.

2.3.3 Location of Process and System Working Set Lists

The base address of the working set list can no longer be found within the process PHD or the system PHD. To obtain the address of the process working set list, use the 64-bit data cell CTL\$GQ_WSL. To obtain the address of the system working set list, use the 64-bit data cell MMG\$GQ_SYSWSL.

Note that pointers to working set list entries must be 64-bit addresses in order to be compatible with future versions of OpenVMS Alpha after Version 7.0.

³ This manual has been archived but is available on the OpenVMS Documentation CD-ROM. This information has also been included in the *OpenVMS Programming Concepts Manual, Volume I*.

Upgrading Privileged Software to OpenVMS Alpha Version 7.0

2.3 General Memory Management Infrastructure Changes

2.3.4 Size of a Working Set List Entry

Each working set list entry (WSLE) residing in the process or the system working set list is now 64 bits in size. Thus, a working set list index must be interpreted as an index into an array of quadwords instead of an array of longwords, and working set list entries must be interpreted as 64 bits in size. Note that the layout of the low bits in the WSLE is unchanged.

2.3.5 Location of Page Frame Number (PFN) Database

Due to the support for larger physical memory systems in OpenVMS Alpha Version 7.0, the PFN database has been moved to S2 space, which can only be accessed with 64-bit pointers. Privileged routine interfaces within OpenVMS Alpha that pass PFN database entry addresses by reference have been renamed to force compile-time or link-time errors.

Privileged code that references the PFN database must be inspected and possibly modified to ensure that 64-bit pointers are used.

2.3.6 Format of PFN Database Entry

The offset `PFN$SL_REFCNT` in the PFN database entry has been replaced with a different-sized offset that is packed together with other fields in the PFN database.

References to the field `PFN$SL_REFCNT` should be modified to use the following macros (located in `PFN_MACROS.H` within `SYSS$LIBRARY:SYSS$LIB_C.TLB`).

- `INCREM` — Increments the PFN's reference count.
- `DECREM` — Decrements the PFN's reference count.

As of OpenVMS Alpha Version 7.0, the offset `PFN$SL_PTE` in the PFN database entry has been replaced with a new PTE backpointer mechanism. This mechanism can support page table entries that reside in 64-bit virtual address space.

References to the field `PFN$SL_PTE` should be modified to use one of the following macros (located in `PFN_MACROS.H` within `SYSS$LIBRARY:SYSS$LIB_C.TLB`).

- `ACCESS_BACKPOINTER` — Accepts a PFN database entry address, and returns a virtual address at which you may access the PTE that maps that PFN.
- `ESTABLISH_BACKPOINTER` — Replaces a write of a PTE address to `PFN$SL_PTE`.
- `TEST_BACKPOINTER` — Replaces a test for zero in `PFN$SL_PTE`.

Note that pointers to PFN database entries must be 64 bits.

2.3.7 Process Header WSLX and BAK Arrays

Prior to OpenVMS Alpha Version 7.0, the process header contained two internal arrays of information that were used to help manage the balance slot contents (specifically, page table pages) during process swapping. These two arrays, along with the working set list index (WSLX) and backing storage (BAK) arrays, no longer are required for page table pages.

Upgrading Privileged Software to OpenVMS Alpha Version 7.0

2.3 General Memory Management Infrastructure Changes

The swapper process now uses the upper-level page table entries and the working set list itself to manage the swapping of page table pages. A smaller version of the BAK array, now used only for backing storage information for balance slot pages, is located at the end of the fixed portion of the process header at the offset PHD\$Q_BAK_ARRAY.

2.3.8 Free S0/S1 System Page Table Entry List

The format of a free page table entry in S0/S1 space has been changed to use index values from the base of page table space instead of the base of S0/S1 space. The free S0/S1 PTE list also uses page table space index values. The list header has been renamed to LDR\$GQ_FREE_S0S1_PT.

2.3.9 Location of the Global Page Table

In order to support larger global sections and larger numbers of global sections in OpenVMS Alpha Version 7.0, the global page table has been moved to S2 space, which can be accessed only with 64-bit pointers.

Privileged code that references entries within GPT must be inspected and possibly modified to ensure that 64-bit pointers are used.

2.3.10 Free Global Page Table Entry List

The format of the free GPT entry has been changed to use index values from the base of the global page table instead of using the free pool list structure. The free GPT entry format is now similar to the free S0/S1 PTE format.

Note that pointers to GPT entries must be 64 bits.

2.3.11 Region Descriptor Entries (RDEs)

As of OpenVMS Alpha Version 7.0, each process virtual addressing region is described by a region descriptor entry (RDE). The program region (P0) and control region (P1) have region descriptor entries that contain attributes of the region and describe the current state of the region. The program region RDE is located at offset PHD\$Q_P0_RDE within the process's PHD. The control region RDE is located at offset PHD\$Q_P1_RDE, also within the process's PHD.

Many internal OpenVMS Alpha memory management routines accept a pointer to the region's RDE associated with the virtual address also passed to the routine.

The following two functions (located in MMG_FUNCTIONS.H in SYSS\$LIBRARY:SYSS\$LIB_C.TLB) are available to obtain the address of an RDE:

- \$lookup_rde_va — Returns the address of the RDE given a virtual address.
- \$lookup_rde_id — Returns the address of the RDE given the region id.

2.4 Kernel Threads Changes

This section describes the OpenVMS Alpha kernel threads features that might require changes to privileged-code applications.

2.4.1 The CPU\$L_CURKTB Field

The CPU\$L_CURKTB field in the CPU databases contains the current kernel thread executing on that CPU. If kernel-mode codes own the SCHED spinlock, then the current KTB address can be obtained from this field. Before kernel threads implementation, this was the current PCB address.

Upgrading Privileged Software to OpenVMS Alpha Version 7.0 2.4 Kernel Threads Changes

2.4.2 Mutex Locking

No changes are necessary to kernel-mode code that locks mutexes. All of SCH\$LOCK*, SCH\$UNLOCK*, and SCH\$IOLOCK* routines determine the correct kernel thread if it must wait because the mutex is already owned.

2.4.3 Scheduling Routines

Code that calls any of the scheduling routines that previously took the current PCB as a parameter must be changed to pass the current KTB. These scheduling routines are as follows:

EXES\$KERNEL_WAIT	SCH\$WAIT_PROC
EXES\$KERNEL_WAIT_PS	SCH\$UNWAIT
SCH\$RESOURCE_WAIT	RPTEVT macro
SCH\$RESOURCE_WAIT_PS	SCH\$REPORT_EVENT
SCH\$RESOURCE_WAIT_SETUP	SCH\$CHANGE_CUR_PRIORITY
SCH\$SCHSE	SCH\$REQUIRE_CAPABILITY
SCH\$SCHSEP	SCH\$RELEASE_CAPABILITY

Code that calls any of the scheduling routines that previously took the process PID as a parameter must be changed to pass the thread's PID. These scheduling routines are as follows:

SCH\$POSTEF	SCH\$WAKE
-------------	-----------

2.4.4 New MWAIT State

A thread that is waiting for ownership of the inner-mode semaphore may be put into MWAIT. The KTB\$\$_EFWM field contains a process-specific MWAIT code. The low word of the field contains RSN\$INNER_MODE, and the upper word contains the process index from the PID.

2.4.5 System Services Dispatching

The system services dispatcher has historically passed the PCB address to the inner-mode services. This is still true with kernel threads. The current KTB is not passed to the services.

2.4.6 Asynchronous System Traps (ASTs)

The ACB\$\$_PID field in the ACB should represent the kernel thread to which the AST is targeted. All other AST context is the same.

Inner-mode ASTs can be delivered on whichever kernel thread is currently in inner mode. ASTs that have the ACB\$\$_THREAD_SAFE bit set will always be delivered to the targeted thread, regardless of other-inner mode activity. Use extreme care if this is used. Attempted thread-safe AST delivery to a kernel thread that has been deleted is delivered to the initial thread.

Upgrading Privileged Software to OpenVMS Alpha Version 7.0

2.4 Kernel Threads Changes

2.4.7 TB Invalidation and Macros

With the kernel threads implementation, the address space for a process can be active on multiple CPUs at the same time. Any privileged code that creates or deletes process virtual address space “by hand” must do the proper invalidation across all CPUs. A set of macros have been created for BLISS, C, and MACRO-32 to facilitate translation buffer invalidation. The macros are as follows:

- TBI_DATA_64
- TBI_SINGLE
- TBI_ALL

Table 2–1 describes the arguments for the TBI_DATA_64 and TBI_SINGLE macros. Note that the difference between TBI_DATA_64 and TBI_SINGLE is that the former invalidates an entry from the data translation buffer only, while the latter invalidates an entry from both the data and the instruction translation buffers.

Table 2–1 Arguments for TBI_DATA_64 and TBI_SINGLE

Keyword	Value	Meaning
ADDR	= The virtual address to be invalidated. The address can be either a 64-bit VA or a sign-extended 32-bit VA. For MACRO-32, the address must be specified in a register.	
ENVIRON	= THIS_CPU_ONLY	Indicates that this invocation of TBIS is to be executed strictly within the context of the local CPU only. Thus, no attempt is made whatsoever to extend the TBIS request to any CPU or other “processor” that might exist within the system.
	= ASSUME_PRIVATE	Indicates that this is a threads environment and that the address should be treated as a private address and not be checked. Therefore, in an SMP environment, it is necessary to do the invalidate to other CPUs that are running a kernel thread from this process. This argument is used for system space addresses that should be treated as private to the process.
	= ASSUME_SHARED	Indicates that this invocation of TBIS should be broadcast to all other CPUs in the system. ASSUME_SHARED is the opposite of THIS_CPU_ONLY.
	= LOCAL	This is now obsolete and generates an error.
	= anything other than the above	Forces the TB invalidate to be extended to all components of the system that may have cached PTEs.

(continued on next page)

Upgrading Privileged Software to OpenVMS Alpha Version 7.0 2.4 Kernel Threads Changes

Table 2–1 (Cont.) Arguments for TBI_DATA_64 and TBI_SINGLE

Keyword	Value	Meaning
PCBADDR	= Address of current process control block. Default is NO_PCB, which means that a PCB address does not need to be specified. The default is R31 for the MACRO-32 macros.	This argument must be specified if the address to be invalidated is process-private (either ENVIRON=ASSUME_PRIVATE or no keyword for the ENVIRON qualifier was specified).

Table 2–2 describes the arguments for the TBI_ALL macro.

Table 2–2 Arguments for TBI_ALL

Keyword	Value	Meaning
ENVIRON	= THIS_CPU_ONLY	Indicates that this invocation of TBI_ALL is to be executed strictly within the context of the local CPU. No attempt is made to extend the TBIA request to any CPU or other “processor” that might exist within the system.
	= LOCAL	This is now obsolete and generates an error.
	= anything other than the above	Forces the TB invalidate to be extended to all components of the system that may have cached PTEs.

2.4.8 New PCB/KTB Fields

Table 2–3 shows the new PCB and KTB fields as defined by PCBDEF.

Table 2–3 New PCB/KTB Fields

Field	Meaning
PCBSK_MAX_KT_COUNT	Maximum number of kernel threads
PCBSL_ACTIVE_CPUS	CPUs owned by this process
PCBSL_TQUANTUM	Per-user thread quantum
PCBSL_MULTITHREAD	Maximum thread count
PCBSL_KT_COUNT	Current thread count
PCBSL_KT_HIGH	Highest KTB vector entry used
PCBSL_KTBVEC	KTB vector address
PCBSL_IM_ASTQFL_SPK	Special kernel AST queue forward link (head)
PCBSL_IM_ASTQBL_SPK	Special kernel AST queue back link (tail)
PCBSL_IM_ASTQFL_K	Kernel AST queue forward link (head)
PCBSL_IM_ASTQBL_K	Kernel AST queue back link (tail)
PCBSL_IM_ASTQFL_E	Executive AST queue forward link (head)
PCBSL_IM_ASTQBL_E	Executive AST queue back link (tail)

(continued on next page)

Upgrading Privileged Software to OpenVMS Alpha Version 7.0

2.4 Kernel Threads Changes

Table 2–3 (Cont.) New PCB/KTB Fields

Field	Meaning
PCBSL_INITIAL_KTB	Initial KTB, overlays KTB\$SL_PCB
KTBSL_PCB	PCB address, overlays PCBSL_INITIAL_KTB
KTBSL_FRED	Address of FRED block
KTBSL_PER_KT_AREA	Address of per-kernel thread data area
KTBSL_TQUANT	Remaining per-user thread quantum
KTBSL_QUANT	Remaining per-kernel thread quantum
KTBSL_TM_CALLBACKS	Address of thread manager callback vector

2.4.9 CTL\$AL_STACK and CTL\$AL_STACKLIM

The two arrays containing stack bounds information are now quadwords. The arrays are now CTL\$AQ_STACK and CTL\$AQ_STACKLIM and are still indexed by access mode. The entries are QUADWORDS.

The arrays pointed to by these two data cells represent only the stack pointers for the initial kernel thread. For a process with multiple kernel threads, the stack arrays are in the per-kernel thread data area. The address of this structure can be found using the KTB\$SL_PER_KT_AREA field. These fields are defined in PKT\$DEF. The initial thread has a permanent per-kernel thread, so no distinction is needed between the initial thread and other threads when accessing this data. Table 2–4 shows the stack arrays.

Table 2–4 Stack Arrays

Array	Meaning
PKT\$AQ_STACK	STACK pointer array
PKT\$AQ_STACKLIM	STACK limit pointer array

2.4.10 Floating-Point Register and Execution Data Blocks (FREDs)

The FRED is defined by FREDDEF. The KTB\$SL_FRED field in the KTB points to the FRED block. The section of the PHD that contains the HWPCB and floating-point register save area for the initial thread is identical to the layout of the FRED. Therefore, no distinction is needed between the initial thread and other threads when accessing this data.

2.5 Registering Images That Have Version Dependencies

Note

The information in this section does not apply to device drivers, nor to any images that reference the following data structures:

- BOD
- CDRP
- CXB
- DCBE
- FDT
- IRP
- IRPE
- PFN

Upgrading Privileged Software to OpenVMS Alpha Version 7.0

2.5 Registering Images That Have Version Dependencies

PHD
UCB
VCRP

The need for change in any image (including device drivers, as well as privileged applications linked against SYSS\$BASE_IMAGE.EXE) is normally detected by a system version check. That check is designed to prevent an application that may need change from producing incorrect results or causing system failures.

The version checks do not necessarily mean that the applications require any change. Compaq recommends that you perform some analysis to determine compatibility for privileged images before you run them on Version 7.0 systems.

OpenVMS Alpha Version 7.0 provides an Image Registry facility that may obviate the need for relinking images when you upgrade from previous versions of OpenVMS Alpha. The Image Registry is a central registry of images (including layered products, customer applications, and third-party software) that have version dependencies but have been identified as being compatible with the OpenVMS operating system software. The products in the registry are exempted from version checking.

The Image Registry facility has several benefits, particularly when you have only image files, not source or object files. In addition, it eases version compatibility problems on mixed-version clusters because the same images can be used on all nodes. It also simplifies the addition of third-party software and device drivers to the system.

The registry is a file that contains registered images. These images include main images (images that you can run directly), shared libraries, and device drivers that are identified by name, the image identification string, and the link time of the image. The registered images bypass normal system version checking in the INSTALL, system image loader, and image activator phases. With the Image Registry facility, images for different versions of applications can be registered independently.

Images linked as part of installation need not be registered because they match the version of the running system. However, linking during installation cannot ensure the absence of system version dependencies.

2.5.1 Version Identification (ID) Number Change to Three Subsystems

The OpenVMS executive defines 18 logical subsystems. Each of these subsystems contains its own version identification (ID) number. This modularization makes it possible for OpenVMS releases to include changes to a portion of the executive, impacting only those privileged programs which use that portion of the executive.

For OpenVMS Alpha Version 7.0, the following 3 subsystems have changed, and their version IDs have been incremented:

- I/O
- Memory Management
- Process Scheduling

Developers should check privileged code (that is, any image linked against the system symbol table SYSS\$BASE_IMAGE.EXE) to determine whether the image is affected by the changes to the subsystems. If the code is affected, the developer should make any necessary changes.

Replacements for Removed Privileged Symbols

This chapter describes the closest equivalent mechanism to a number of internal routines, data structure cells, and system data cells that have been removed in OpenVMS Alpha Version 7.0.

Each table lists the previous name, any replacements, and a brief explanation.

Important

The internal data structure fields, routines, macros, and data cells described in this chapter should not be interpreted as being part of the documented interfaces that drivers or other privileged software should routinely depend on.

If you were using the removed mechanism correctly, this chapter will assist you in using the closest equivalent in OpenVMS Alpha Version 7.0. However, you should not use this as an opportunity to start using these mechanisms. Doing so is likely to increase the work required to maintain compatibility of your privileged software with future releases of OpenVMS.

Replacements for Removed Privileged Symbols

3.1 Removed Date Structure Fields

3.1 Removed Date Structure Fields

Table 3–1 lists the data structure fields that have been removed as of OpenVMS Alpha Version 7.0.

Table 3–1 Removed Date Structure Fields

Removed Field	Replacement	Comments
BOD\$\$_BASEPVA	BOD\$PQ_BASEPVA	64-bit process virtual address of buffer mapped by the buffer object. See Appendix A.
CDR\$\$_AST	cdr\$PQ_acb64_ast	Increased to a quadword and renamed.
CDR\$\$_ASTPRM	CDR\$PQ_A	See Appendix A.
CDR\$\$_IOSB	CDR\$PQ_IOSB	See Appendix A.
CPT\$\$_IOVA	CPT\$PQ_IOVA	Increased to a quadword and renamed.
DMP\$\$_BITS_12_15	Still have this field.	Same value.
DMP\$\$_BITS_12_15	Still have this field.	Same value.
DMP\$\$_BITS_12_15	Still have this field.	Same value.
DYN\$\$_F64_F64DATA	TBS—Dollar	
DYN\$\$_NET_TIM_TEB	DYN\$\$_NET_TIM_NTEB	Renamed because the DECnet structure it indicates (network timer element block) was renamed from TEB to NTEB.
FDT_CONTEXT\$\$_QIO_R1_VALUE	FDT_CONTEXT\$PQ_QIO_R1_VALUE	See Appendix A.
IRP\$\$_AST	IRP\$PQ_ACB64_AST	Removed to ensure that any reference to the \$QIO astadr via a 32-bit address and astprm as a 32-bit value are detected at compile-time or link-time.
IRP\$\$_ASTPRM	IRP\$PQ_ACB64_ASTPRM	Removed to ensure that any reference to the \$QIO astadr via a 32-bit address and astprm as a 32-bit value are detected at compile-time or link-time.
IRP\$\$_IOSB	IRP\$PQ_IOSB	Removed to ensure that any reference to the \$QIO iosb via a 32-bit address is detected at compile-time or link-time.
IRPE\$\$_BCNT1	IRPE\$\$_BCNT	See Appendix A.
IRPE\$\$_BCNT2	None.	Removed.
IRPE\$\$_BOFF1	IRPE\$\$_BOFF	See Appendix A.
IRPE\$\$_BOFF2	None.	Removed.
IRPE\$\$_SVAPTE1	IRPE\$\$_SVAPTE	
IRPE\$\$_SVAPTE2	None.	Removed.
LCKCTX\$\$_CPLADR	LCKCTX\$PQ_CPLADR	Increased in length to quadword.
LCKCTX\$\$_CPLPRM	LCKCTX\$PQ_CPLPRM	Increased in length to quadword.

(continued on next page)

Replacements for Removed Privileged Symbols

3.1 Removed Date Structure Fields

Table 3–1 (Cont.) Removed Date Structure Fields

Removed Field	Replacement	Comments
LCKCTXSL_CR3	LCKCTXSQ_CR3	Increased in length to quadword.
LCKCTXSL_CR4	LCKCTXSQ_CR4	Increased in length to quadword.
LCKCTXSL_CR5	LCKCTXSQ_CR5	Increased in length to quadword.
LCKCTXSL_CRETADR	LCKCTXSPQ_CREADR	Increased in length to quadword.
LCKCTXSL_CTX_PRM1	LCKCTXSQ_CTX_PRM1	Increased in length to quadword.
LCKCTXSL_CTX_PRM2	LCKCTXSQ_CTX_PRM2	Increased in length to quadword.
LCKCTXSL_CTX_PRM3	LCKCTXSQ_CTX_PRM3	Increased in length to quadword.
LCKCTXSL_RET1	LCKCTXSPQ_RET1	Increased in length to quadword.
LCKCTXSL_TMP1	LCKCTXSQ_TMP1	Increased in length to quadword.
LKB\$C_ACBLEN	Removed.	
LKB\$K_ACBLEN	Removed.	
LKB\$L_AST	LKB\$PQ_AST	Increased in length to quadword.
LKB\$L_ASTPRM	LKB\$Q_ASTPRM	Increased in length to quadword.
LKB\$L_BLKASTADR	LKB\$PQ_CPLASTADR	Increased in length to quadword.
LKB\$L_CPLASTADR	LKB\$PQ_CPLASTADR	Increased in length to quadword.
LKB\$L_LKSB	LKB\$PQ_LKSB	Increased in length to quadword.
LKB\$L_OLDASTPRM	LKB\$Q_OLDASTPRM	Increased in length to quadword.
LKB\$L_OLDBLKAST	LKB\$PQ_OLDBLKAST	Increased in length to quadword.
LMB\$C_GBL	No name change.	Value changed from 2 to 3.
LMB\$C_PROCESS	No name change.	Value changed from 3 to 4.
LMB\$C_S0	LMB\$C_S0S1	Value = 1
LMB\$C_SPT	LMB\$C_SPTW	Not guaranteed to be in a dump.
LMB\$L_BAD_MEM_END	LMB\$PQ_BAD_MEM_END	Supports a 64-bit address.
LMB\$L_BAD_MEM_START	LMB\$PQ_BAD_MEM_START	Supports a 64-bit address.
LMB\$L_HOLE_START_VA	LMB\$PQ_BAD_MEM_START	Supports a 64-bit address.
LMB\$L_HOLE_TOTAL_PAGES	LMB\$Q_HOLE_TOTAL_PAGES	Supports a 64-bit address.
MMG\$C_PTSPACE_OFFSET MMG\$K_PTSPACE_OFFSET	MMG\$GL_L1_INDEX	Compile-time constant that defined a fixed base address for page table address space. This has been replaced by a run-time mechanism which chooses a base address for page table address space during bootstrap, with the index of level 1 page table entry used to map the page tables stored in the new data cell.
PCB\$L_ADB_LINK	None	Supported a feature that was never implemented.
PCB\$L_PSX_ACTPRM	PCB\$Q_PSX_ACTPRM	Increased in length to quadword.
PCB\$L_TOTAL_EVTAST	None	Supported a feature that was never implemented.

(continued on next page)

Replacements for Removed Privileged Symbols

3.1 Removed Date Structure Fields

Table 3–1 (Cont.) Removed Date Structure Fields

Removed Field	Replacement	Comments
PFN\$C_ENTRY_SHIFT_SIZE	None	The size of a single PFN database entry was formerly a power of two. As of Version 7.0, that is no longer true and the symbol was deleted.
PFN\$SL_PTE		This offset in the PFN database was replaced with a new PTE backpointer mechanism that is capable of supporting page table entries that reside in 64-bit virtual address space. Any code that formerly touched PFN\$SL_PTE must be recoded to use one of the following macros supplied in LIB.MLB: ACCESS_BACKPOINTER ESTABLISH_BACKPOINTER TEST_BACKPOINTER
	ACCESS_BACKPOINTER	Accepts a PFN database entry address and returns a virtual address at which you may access the PTE that maps that PFN. This replaces a fetch of a SVAPTE from PFN\$SL_PTE, which would subsequently be used as an operand for a memory read or write instruction.
	ESTABLISH_BACKPOINTER	Replaces a write of a SVAPTE to PFN\$SL_PTE.
	TEST_BACKPOINTER	Replaces a test for zero in PFN\$SL_PTE.
PFN\$SL_REFCNT	INCREP DECREP	This offset in the PFN database was replaced with a differently sized offset that is packed together with other fields in the PFN database. The supplied macro INCREP should be used to replace any existing increment of the value in PFN\$SL_REFCNT, while DECREP should be used to replace any existing decrement.

(continued on next page)

Replacements for Removed Privileged Symbols

3.1 Removed Date Structure Fields

Table 3–1 (Cont.) Removed Date Structure Fields

Removed Field	Replacement	Comments
PFN\$\$_WSLX	PFN\$\$_WSLX_QW	This offset was renamed to reflect a fundamental change in working set list indexes. Prior to Version 7.0, the working set list index (WSLX) was a longword index. The WSLX has become a quadword index as of Version 7.0, therefore the name of the offset was changed to focus attention on existing code that must be changed to view the value stored at this offset as a quadword index rather than as a longword index.
PHD\$\$_PHDPAGCTX	None	Supported a feature that was never implemented.
PHD\$\$_BAK	PHD\$\$_BAK_ARRAY	PHD\$\$_BAK contained an offset to an internally maintained array which was used to support swapping of the balance slot contents. As of Version 7.0, the implementation of this array changed to better accommodate the balance slot contents. PHD\$\$_BAK was replaced by PHD\$\$_BAK_ARRRAY which is the symbolic offset from the start of the process header to where this array begins.
PHD\$\$_L2PT_VA	L2PTE_VA	This process header offset formerly contained the system space address of the process's level 2 page table page that was used to map P0 and P1 spaces. As of Version 7.0, the page tables no longer reside in the balance slot, and a process is no longer limited to having only one level 2 page table page. This offset was used to derive addresses of level 2 page table entries. Use the L2PTE_VA macro to derive from a given VA the address of the level 2 PTE that maps that VA.
PHD\$\$_L3PT_VA PHD\$\$_L3PT_VA_P1	PTE_VA	These process header offsets formerly contained the system space addresses of the bases of the P0 and P1 page tables that resided in the process's balance slot. As of Version 7.0, the page tables no longer reside in the balance slot, and the conceptual overlap of the P0 and P1 page tables in virtual memory no longer exists. Use the PTE_VA macro to derive from a given VA the address of the level 3 PTE that maps that VA.

(continued on next page)

Replacements for Removed Privileged Symbols

3.1 Removed Date Structure Fields

Table 3–1 (Cont.) Removed Date Structure Fields

Removed Field	Replacement	Comments
PHD\$SL_POLENGTH	None	Different page table layout.
PHD\$SL_P1LENGTH	None	Different page table layout.
PHD\$SL_PSTBASMAX	PHD\$SL_PST_BASE_MAX	Contains new-style section index.
PHD\$SL_PSTBASOFF	PHD\$SL_PST_BASE_OFFSET	Name changed.
PHD\$SL_PSTFREE	PHD\$SL_PST_FREE	Contains new-style section index.
PHD\$SL_PSTLAST	PHD\$SL_PST_LAST	Contains new-style section index.
PHD\$SL_PTWSLELCK	PFN database	These process header offsets formerly contained internal bookkeeping information for managing page table pages for a process. These have been replaced by a bookkeeping mechanism that resides in the PFN database entries for page table pages. It is highly unlikely that anyone is affected by this change.
PHD\$SL_PTWSLEVAL		
PHD\$SL_QUANT	KTBS\$SL_QUANT	
PHD\$SL_WSL	CTL\$GQ_WSL	You can no longer count on WSL (data cell) following PHD, use pointer to WSL in CTL\$GQ_WSL instead.
PHD\$SL_WSLX	None	WSLX array is no longer in PHD as a result of the new swapper design.
PTE\$SL_COUNT	PTE\$SL_FREE_COUNT	Offset to the number of free PTEs in a free PTE structure.
PTE\$SL_LINK	PTE\$SQ_INDEX	Contains an index to the next free element in the free PTE list. The contents of the field is a quadword index off the base of page table space. Free system PTEs and free global PTEs are linked together in this manner.
PTE\$SM_SINGLE_SPTE	PTE\$SM_SINGLE_PTE	A mask or flag denoting whether a free element describes a single PTE or multiple PTEs.
PTE\$V_SINGLE_SPTE	None	The contents of a free PTE element are AND'ed with PTE\$SM_SINGLE_PTE to determine whether the element describes a single PTE.

Replacements for Removed Privileged Symbols

3.2 Removed Routines

3.2 Removed Routines

Table 3–2 lists the routines that have been removed as of OpenVMS Alpha Version 7.0.

Table 3–2 Removed Routines

Removed Routine	Replacement	Comments
MMG\$ALCSTX	MMG_STD\$ALCSTX	Returns new-style section index.
MMG\$ALLOC_PFN_ALGND	MMG\$ALLOC_PFN_ALGND_64	MMG\$ALLOC_PFN_ALGND_64 should not be called directly. Instead, use the ALLOCPFN macro. Note that 64-bit virtual addresses are required to access PFN database entries.
MMG\$ALLOC_ZERO_ALGND	MMG\$ALLOC_ZERO_ALGND_64	MMG\$ALLOC_ZERO_ALGND_64 should not be called directly. Instead, use the ALLOC_ZERO_PFN macro. Note that 64-bit virtual addresses are required to access PFN database entries.
MMG\$CREPAG	MMG\$CREPAG_64 MMG_STD\$CREPAG_64	Accepts 64-bit addresses and has 3 new inputs: RDE (R12), pagefile_cache (R13) mmg_flags (R14). See mmg_routines.h for STD interface.
MMG\$DALCSTX	MMG_STD\$DALCSTX	Accepts new-style section index.
MMG\$DECPTREF	MMG_STD\$DECPTREF_PFNDB MMG_STD\$DECPTREF_GPT	MMG\$DECPTREF expected a 32-bit system space address of a PTE as an input parameter. Page table entries are now located in 64-bit addressable memory. This routine was replaced by two routines: MMG_STD\$DECPTREF_PFNDB and MMG_STD\$DECPTREF_GPT. MMG_STD\$DECPTREF_PFNDB accepts as input a 64-bit virtual address of a PFN database entry for a page table, the reference count of which is to be decremented. MMG_STD\$DECPTREF_GPT, accepts as input a 64-bit virtual address of a global page table entry, which lies within a certain global page table page, of which a reference count must be decremented.
MMG\$DECSECREFL	MMG_STD\$DECSECREFL	Accepts new-style section index.
MMG\$DELPAFL	MMG\$DELPAFL_64 MMG_STD\$DELPAFL_64	Accepts 64-bit addresses and has 2 new inputs, RDE (R12) and mmg_flags (R14). See mmg_routines.h for STD interface.

(continued on next page)

Replacements for Removed Privileged Symbols

3.2 Removed Routines

Table 3–2 (Cont.) Removed Routines

Removed Routine	Replacement	Comments
MMG\$DELWSLEPPG	MMG_STD\$DELWSLEPPG_64	Replacement reflects a change in input from a 32-bit addressable system space address of a PTE to a 64-bit address of a PTE in page table space. Other argument changes may have occurred as well.
MMG\$DELWSLEX	MMG_STD\$DELWSLEX_64	Replacement reflects a change in input from a 32-bit addressable system space address of a PTE to a 64-bit address of a PTE in page table space. Other argument changes may have occurred as well.
MMG\$FREWSLX	MMG\$FREWSLX_64	Replacement reflects a change in input from a 32-bit addressable system space address of a PTE to a 64-bit address of a PTE in page table space. Other argument changes may have occurred as well.
MMG\$GETGSNAM	MMG_STD\$GETGSNAM	Converted to STD interface. (No prototype in mmg_routines.h.)
MMG\$GSDSCAN	MMG_STD\$GSDSCAN	Converted to STD interface. See mmg_routines.h for interface definition.
MMG\$INCPTRF	MMG_STD\$INCPTRF_64	Replacement reflects a change in input from a 32-bit addressable system space address of a PTE to a 64-bit address of a PTE in page table space. Other argument changes may have occurred as well.
MMG\$INIBLDPKT	None	This routine was used internally only. Its symbol has been removed from the base image.
MMG\$ININEW_PFN	MMG_STD\$ININEWPFN_64	Replacement reflects a change in input from a 32-bit addressable system space address of a PTE to a 64-bit address of a PTE in page table space. Other argument changes may have occurred as well.
MMG\$INIT_PGFLQUOTA	MMG_STD\$INIT_PGFLQUOTA \$INIT_PGFLQUOTA	Converted to STD interface. See mmg_functions.h for interface definition.
MMG\$IN_REGION	MMG_STD\$IN_REGION_64 \$IN_REGION_64	Converted to STD interface. See mmg_functions.h for interface definition.
MMG\$IOLOCK	MMG_STD\$IOLOCK_BUF	See Appendix B.
MMG\$LOCKPGTB	MMG_STD\$LOCKPGTB_64	Replacement reflects a change in input from a 32-bit addressable system space address of a PTE to a 64-bit address of a PTE in page table space. Other argument changes may have occurred as well.

(continued on next page)

Replacements for Removed Privileged Symbols

3.2 Removed Routines

Table 3–2 (Cont.) Removed Routines

Removed Routine	Replacement	Comments
MMG\$MAKE_WSLE	MMG_STD\$MAKE_WSLE_64	Replacement reflects a change in input from a 32-bit addressable system space address of a PTE to a 64-bit address of a PTE in page table space. Other argument changes may have occurred as well.
MMG\$MORE_PGFLQUOTA	MMG_STD\$MORE_PGFLQUOTA \$MORE_PGFLQUOTA	Converted to STD interface. See <code>mmg_functions.h</code> for interface definition.
MMG\$MOVPTLOCK MMG\$MOVPTLOCK1	None	Page table locking redesign has obviated these routines. No replacement exists.
MMG\$PTEINDX	None	Used internally only. Obviated by design as of Version 7.0.
MMG\$PTEREF	MMG\$PTEREF_64	This replacement reflects a change in interface including <code>MMG_\$PTEREF</code> acceptance as input a 64-bit virtual address.
MMG\$PURGEMPL	MMG\$PURGE_MPL	Renamed because the interface changed slightly. This is a JSB entry with arguments in R0-R2. It now accepts an additional argument in R3, the PTBR of the process owning the PTEs, for range-based requests. This request type also now accepts 64-bit PTE addresses rather than 32-bit SVAPTE addresses.
MMG\$SUBSECREFL	MMG_STD\$DECSECREFL	Accepts new-style section index.
MMG\$SUBSECREFL	MMG_STD\$SUBSECREFL	Accepts new-style section index.
MMG\$TBI_SINGLE_64	TBI_SINGLE Macro	<code>MMG\$TBI_SINGLE_64</code> should not be called directly. Instead, use the <code>TBI_SINGLE</code> macro.
MMG\$TRY_ALL	MMG_STD\$TRY_ALL_64	Converted to STD interface. See <code>mmg_routines.h</code> for interface definition.
MMG\$ULKGBLWSL	None	This routine was used internally only. Its symbol has been removed from the base image.
MMG\$UNLOCK	MMG_STD\$IOUNLOCK_BUF	See Appendix B.
MMG_STD\$ALLOC_PFN	MMG_STD\$ALLOC_PFN_64	This routine should not be called directly. Instead, use the <code>ALLOC_PFN</code> macro. Note that 64-bit virtual addresses are required to access PFN database entries.
MMG_STD\$ALLOC_ZERO_PFN	MMG_STD\$ALLOC_ZERO_PFN_64	This routine should not be called directly. Instead, use the <code>ALLOC_ZERO_PFN</code> macro. Note that 64-bit virtual addresses are required to access PFN database entries.

(continued on next page)

Replacements for Removed Privileged Symbols

3.2 Removed Routines

Table 3–2 (Cont.) Removed Routines

Removed Routine	Replacement	Comments
MMG_STD\$DALLOC_PFN	MMG_STD\$DALLOC_PFN_64	Note that 64-bit virtual addresses are required to access PFN database entries.
MMG_STD\$DEL_PFNLIST	MMG_STD\$DEL_PFNLIST_64	Note that 64-bit virtual addresses are required to access PFN database entries.
MMG_STD\$ININEW_PFN	MMG_STD\$ININEWPFN_64	Note that 64-bit virtual addresses are required to access PFN database entries.
MMG_STD\$INS_PFNH	MMG_STD\$INS_PFNH_64	Note that the 64-bit virtual addresses are required to access PFN database entries.
MMG_STD\$INS_PFNNT	MMG_STD\$INS_PFNNT_64	Note that the 64-bit virtual addresses are required to access PFN database entries.
MMG_STD\$IOLOCK	MMG_STD\$IOLOCK_BUF	See Appendix B.
MMG_STD\$PTEINDX	None	Used internally only. Obviated by design as of OpenVMS Alpha Version 7.0.
MMG_STD\$REL_PFN	MMG_STD\$REL_PFN_64	Note that the 64-bit virtual addresses are required to access PFN database entries.
MMG_STD\$REM_PFN	MMG_STD\$REM_PFN_64	Note that the 64-bit virtual addresses are required to access PFN database entries.
MMG_STD\$REM_PFNH	MMG_STD\$REM_PFNH_64	Note that the 64-bit virtual addresses are required to access PFN database entries.
MMG_STD\$TBI_SINGLE_64	TBI_SINGLE Macro	MMG_STD\$TBI_SINGLE_64 should not be called directly. Instead, use the TBI_SINGLE macro.
MMG_STD\$UNLOCK	MMG_STD\$IOUNLOCK_BUF	See Appendix B.
SWP\$FILL_L1L2_PT	None	Removed.

3.3 Removed Macros

This section lists the macros that have been removed as of OpenVMS Alpha Version 7.0.

3.3.1 Removed MACRO-32 Macros Formerly in SYS\$LIBRARY:LIB.MLB

- \$VADEF — Moved to SYS\$LIBRARY:STARLET.MLB
- TBI_SINGLE_64 — MMG\$TBI_SINGLE_64

3.3.2 C Header Files Removed From SYS\$LIBRARY:SYS\$LIB_C.TLB

- msb_codec_reg.h
- msb_reg.h
- vdef.h — Moved to SYS\$LIBRARY:SYS\$STARLET_C.TLB

Replacements for Removed Privileged Symbols

3.4 Removed System Data Cells

3.4 Removed System Data Cells

Table 3–3 lists the system data cells that have been removed as of OpenVMS Alpha Version 7.0.

Table 3–3 Removed System Data Cells

Removed Cell	Replacement	Comments
CTLSAL_STACK	CTLSAQ_STACK	Arrays are now quadwords.
CTLSAL_STACKLIM	CTLSAQ_STACKLIM	Arrays are now quadwords.
EXESGL_GPT	MMG\$GQ_FREE_GPT	As of Version 7.0, free GPTEs are managed in the same manner as free system PTEs. Note that 64-bit virtual addresses are required to access GPTEs.
LDR\$GL_FREE_PT	LDR\$GQ_FREE_S0S1_PT	Contains the address of the start of the free S0/S1 PTE list. The format of the free PTEs has changed for Version 7.0.
MMG\$GL_FRESVA	MMG\$GQ_NEXT_FREE_S0S1_VA	
MMG\$GL_GPTBASE	MMG\$GQ_GPT_BASE	As of Version 7.0, free GPTEs are managed in the same manner as free system PTEs. Note that 64-bit virtual addresses are required to access GPTEs.
MMG\$GL_MAXGPTE	MMG\$GQ_MAX_GPTE	As of Version 7.0, free GPTEs are managed in the same manner as free system PTEs. Note that 64-bit virtual addresses are required to access GPTEs.
MMG\$GL_P0_PTLEN	None	Obviated by the removal of the process page tables from the balance slot.
MMG\$GL_PX_VPN_LENGTH	None	This data cell is obviated by the removal of the process page tables from the balance slot.
MMG\$GL_RESERVED_SVA	MMG\$GQ_WINDOW_VA	Increased in length to quadword.
MMG\$GL_RESERVED_SVA2	MMG\$GQ_WINDOW2_VA	Increased in length to quadword. (continued on next page)

Replacements for Removed Privileged Symbols

3.4 Removed System Data Cells

Table 3–3 (Cont.) Removed System Data Cells

Removed Cell	Replacement	Comments
MMG\$GL_RESERVED_SVAPTE	MMG\$GQ_WINDOW_PTE_PFN	64-bit pointer to PFN field of first reserved PTE.
MMG\$GL_RESERVED_SVAPTE2	MMG\$GQ_WINDOW2_PTE_PFN	64-bit pointer to PFN field of second reserved PTE.
MMG\$GL_SHARED_L2PT_PFN	None	This cell was deleted since it is possible to have more than one shared L2PT. That is system space may span over multiple L2PTs.
MMG\$GL_SPT_L2PTE_BIAS	None	This cell was deleted since it is possible to have more than one shared L2PT. That is system space may span over multiple L2PTs.
MMG\$GL_VA_TO_PX_VPN	None	This data cell has been completely obviated by the removal of the process page tables from the balance slot.
MMG\$GL_ZERO_SVA	MMG\$GQ_WINDOW_VA	Increased in length to quadword.
MMG\$GL_ZERO_SVAPTE_PFN	MMG\$GQ_WINDOW_PTE_PFN	64-bit pointer to PFN field of reserved PTE.
MMG\$GQ_PT_VA	MMG\$GQ_PT_BASE	MMG\$GQ_PT_VA was renamed to ensure that any code that had assumed a fixed location of page table space as a function of page size would be revisited. The location of page table space is now variable to meet the individual bootstrap needs of supporting Version 7.0, as well as being a function of the page size.
MPW\$GW_HILIM	MPW\$GL_HILIM	Increased in length to a longword.
MPW\$GW_LOLIM	MPW\$GL_LOLIM	Increased in length to a longword.
PFN\$GB_LENGTH	None	

(continued on next page)

Replacements for Removed Privileged Symbols

3.4 Removed System Data Cells

Table 3–3 (Cont.) Removed System Data Cells

Removed Cell	Replacement	Comments
PFN\$PL_DATABASE	PFN\$PQ_DATABASE	The PFN database was moved to S2 space, which is only addressable with 64-bit pointers.
PHV\$GL_REFCBAS	PHV\$GL_REFCBAS_LW	The process header reference count vector has been promoted from an array of words to an array of longwords.
SGN\$GL_PHDAPCNT	None	This cell was deleted as a result of moving the process page tables out of the balance slot.
SGN\$GL_PHDP1WPAG	None	This cell was deleted as a result of moving the process page tables out of the balance slot.
SGN\$GL_PHDRESPAG	None	This cell was deleted as a result of moving the process page tables out of the balance slot.
SGN\$GL_PTPAGCNT	None	This cell was deleted as a result of moving the process page tables out of the balance slot.
SWP\$GL_L1PT_SVAPTE	None	L1 page table now mapped virtually in page table space.
SWP\$GL_L1PT_VA	None	L1 page table now mapped virtually in page table space.
SWP\$GW_BAKPTE	None	This cell was deleted as a result of moving the process page tables out of the balance slot.

Part II

Enhancing Privileged-Code Applications

Modifying Device Drivers to Support 64-Bit Addressing

This chapter describes how to modify customer-written device drivers to support 64-bit addresses.

For more information about the data structures and routines described in this chapter, see Appendix A and Appendix B.

4.1 Recommendations for Modifying Device Drivers

Before you can modify a device driver to support 64-bit addresses, your driver must recompile and relink without errors on OpenVMS Alpha Version 7.0. See Chapter 2. If you are using OpenVMS-supplied FDT routines, supporting 64-bit addresses can be automatic or easily obtained. Device drivers written in C are usually easier to modify than drivers written in MACRO-32. Drives using direct I/O are usually easier to modify than those using buffered I/O.

When your device driver runs successfully as a 32-bit addressable driver on OpenVMS Alpha Version 7.0, you can modify it to support 64-bit addresses as follows:

- Select the functions that you want to support 64-bit functions.
- Follow your `IRP$QIO_P1` value and promote all references to 64-bit addresses.
- Declare 64-bit support for the I/O function.

The remaining sections in this chapter provide more information about these recommendations.

4.2 Mixed Pointer Environment in C

OpenVMS Alpha 64-bit addressing support for mixed pointers includes the following features:

- OpenVMS Alpha 64-bit virtual address space layout that applies to all processes. (There are no special 64-bit processes or 32-bit processes.)
- 64-bit pointer support for addressing the entire 64-bit OpenVMS Alpha address space layout including P0, P1, and P2 address spaces and S0/S1, S2, and page table address spaces.
- 32-bit pointer compatibility for addressing P0, P1, and S0/S1 address spaces.
- Many new 64-bit system services which support P0, P1, and P2 space addresses.
- Many existing system services enhanced to support 64-bit addressing.

Modifying Device Drivers to Support 64-Bit Addressing

4.2 Mixed Pointer Environment in C

- 32-bit sign-extension checking for all arguments passed to 32-bit pointer only system services.
- C and MACRO-32 macros for handling 64-bit addresses.

To support 64-bit addresses in device drivers, you must use the new version (V5.2) of the DEC C compiler as follows:

- Compile your device driver using `/POINTER_SIZE=32`

```
$ CC/STANDARD=RELAXED_ANSI89 -
  /INSTRUCTION=NOFLOATING_POINT -
  /EXTERN=STRICT -
  /POINTER_SIZE=32 -
  LRDRIVER+SYS$LIBRARY:SYS$LIB_C.TLB/LIBRARY
```

- `#pragma __required_pointer_size 32 | 64`
- 64-bit pointer types are defined by header files; e.g.

```
#include <far_pointers.h>
VOID_PQ user_va; /* 64-bit "void *" */
...
#include <ptedef.h>
PTE * svapte; /* 32-bit pointer to a PTE */
PTE_PQ va_pte; /* Quadword pointer to a PTE */
PTE_PPQ vapte_p; /* Quadword pointer to a
                  * quadword pointer to a PTE */
```

- Pointer size truncation warning

```
p0_va = p2_va;
^
%CC-W-MAYLOSEDATA, In this statement, "p2_va" has
a larger data size than "short pointer to char"
```

4.3 \$QIO Support for 64-Bit Addresses

The \$QIO and \$QIOW system services accept the following arguments:

```
$QIO[W] efn,chan,func,iosb,astadr,astprm,p1,p2,p3,p4,p5,p6
```

These services have a 64-bit friendly interface (as described in *OpenVMS Alpha Guide to 64-Bit Addressing and VLM Features*)¹, which allows these services to support 64-bit addresses.

Table 4–1 summarizes the changes to the data types of the \$QIO and \$QIOW system service arguments to accommodate 64-bit addresses.

Table 4–1 \$QIO[W] Argument Changes

Argument	Prior Type	New Type	Description
efn	Unsigned longword	-	Event flag number. Unchanged.
chan	Unsigned word	-	Channel number. Unchanged.

(continued on next page)

¹ This manual has been archived but is available on the OpenVMS Documentation CD-ROM. This information has also been included in the *OpenVMS Programming Concepts Manual, Volume I*.

Modifying Device Drivers to Support 64-Bit Addressing

4.3 \$QIO Support for 64-Bit Addresses

Table 4–1 (Cont.) \$QIO[W] Argument Changes

Argument	Prior Type	New Type	Description
func	Unsigned longword	-	I/O function code. Unchanged.
iosb	32-bit pointer ¹	64-bit pointer	Pointer to a quadword I/O status block (IOSB). The IOSB format is unchanged.
astadr	32-bit pointer ¹	64-bit pointer	Procedure value of the caller's AST routine. On Alpha systems, the procedure value is a pointer to the procedure descriptor.
astprm	Unsigned longword ²	Quadword	Argument value for the AST routine.
P1	Longword ²	Quadword	Device-dependent argument. Often P1 is a buffer address.
P2	Longword ²	Quadword	Device-dependent argument. Only the low-order 32-bits will be used by system-supplied FDT routines that use P2 as the buffer size.
P3	Longword ²	Quadword	Device-dependent argument.
P4	Longword ²	Quadword	Device-dependent argument.
P5	Longword ²	Quadword	Device-dependent argument.
P6	Longword ²	Quadword	Device-dependent argument. Sometimes P6 is used to contain the address of a diagnostic buffer.

¹32-bit pointer was sign-extended to 64 bits as required by the *OpenVMS Calling Standard*.

²32-bit longword value was sign-extended to 64 bits as required by the *OpenVMS Calling Standard*.

Usually the \$QIO P1 argument specifies a buffer address. All the system-supplied upper-level FDT routines that support the read and write functions use this convention. The P1 argument determines whether the caller of the \$QIO service requires 64-bit support. If the \$QIO system service rejects a 64-bit I/O request, the following fatal system error status is returned:

```
SS$_NOT64DEVFUNC 64-bit address not supported by device for this function
```

This fatal condition value is returned under the following circumstances:

- The caller has specified a 64-bit virtual address in the P1 device dependent argument, but the device driver does not support 64-bit addresses with the requested I/O function.
- The caller has specified a 64-bit address for a diagnostic buffer, but the device driver does not support 64-bit addresses for diagnostic buffers.
- Some device drivers may also return this condition value when 64-bit buffer addresses are passed using the P2 through P6 arguments and the driver does not support a 64-bit address with the requested I/O function.

For more information about the \$QIO, \$QIOW, and \$SYNCH system services, see the *OpenVMS System Services Reference Manual: GETUTC-Z*.

Modifying Device Drivers to Support 64-Bit Addressing

4.4 Declaring Support for 64-Bit Addresses in Drivers

4.4 Declaring Support for 64-Bit Addresses in Drivers

Device drivers declare that they can support a 64-bit address by individual function. The details vary depending on the language used to code the initialization of the driver's Function Decision Table.

4.4.1 Drivers Written in C

Drivers written in C use the `ini_fdt_act` macro to initialize an FDT entry for an I/O function. This macro uses the `DRIVER$INI_FDT_ACT` routine. Both the macro and the routine have been enhanced for OpenVMS Alpha Version 7.0.

The format of the macro in releases prior to OpenVMS Alpha Version 7.0 was:

```
ini_fdt_act (fdt, func, action, bufflag)
```

where the `bufflag` parameter must be one of the following:

<code>BUFFERED</code>	The specified function is buffered.
<code>NOT_BUFFERED</code>	The specified function is direct. This is a synonym for <code>DIRECT</code> .
<code>DIRECT</code>	The specified function is direct. This is a synonym for <code>NOT_BUFFERED</code> .

The use of the `bufflag` parameter has been enhanced to include the declaration of 64-bit support by allowing 3 additional values:

<code>BUFFERED_64</code>	The specified function is buffered and supports a 64-bit address in the <code>p1</code> parameter.
<code>NOT_BUFFERED_64</code>	The specified function is direct and supports a 64-bit address in the <code>p1</code> parameter.
<code>DIRECT_64</code>	The specified function is direct and supports a 64-bit address in the <code>p1</code> parameter.

If a driver does not support a 64-bit address on any of its functions, there is no need to change its use of the `ini_fdt_act` macro.

For example, the following C code segment declares that the `IO$_READVBLK` and `IO$_READLBLK` functions support 64-bit addresses.

```
ini_fdt_act (&driver$fdt, IO$_SENSEMODE, my_sensemode_fdt, BUFFERED);  
ini_fdt_act (&driver$fdt, IO$_SETMODE, my_setmode_fdt, BUFFERED);  
ini_fdt_act (&driver$fdt, IO$_READVBLK, acp_std$readblk, DIRECT_64);  
ini_fdt_act (&driver$fdt, IO$_READLBLK, acp_std$readblk, DIRECT_64);
```

The interpretation of the `bufflag` parameter to the `DRIVER$INI_FDT_ACT` routine has been enhanced to support the new values and the setting of the 64-bit support mask in the FDT data structure.

4.4.2 Drivers Written in MACRO-32

As of OpenVMS Alpha Version 7.0, drivers written in MACRO-32 use a new `FDT_64` macro to declare the set of I/O functions for which the driver supports 64-bit addresses. The use of the `FDT_64` macro is similar to the use of the existing `FDT_BUF` macro. If a driver does not support a 64-bit address on any of its functions, there is no need to use the new `FDT_64` macro.

For example, the following MACRO-32 code segment declares that the `IO$_READVBLK` and `IO$_READLBLK` functions support 64-bit addresses.

Modifying Device Drivers to Support 64-Bit Addressing

4.4 Declaring Support for 64-Bit Addresses in Drivers

```
FDT_INI    MY_FDT
FDT_BUF    <SENSEMODE, SETMODE>
FDT_64     <READVBLK, READLBLK>
FDT_ACT    ACP_STD$READBLK, <READVBLK, READLBLK>
```

4.4.3 Drivers Written in BLISS

As of OpenVMS Alpha Version 7.0, drivers written in BLISS-32 and BLISS-64 use a new optional keyword parameter, FDT_64, to the existing FDTAB macro to declare the set of I/O functions that support 64-bit addresses. The use of the new FDT_64 parameter is similar to the use of the existing FDT_BUF parameter. If a driver does not support a 64-bit address on any of its functions, there is no need to use the new FDT_64 parameter.

For example, the following BLISS code segment declares that the IOS_READVBLK and IOS_READLBLK functions support 64-bit addresses.

```
FDTAB (
    FDT_NAME = MY_FDT,
    FDT_BUF  = (SENSEMODE, SETMODE),
    FDT_64   = (READVBLK, READLBLK),
    FDT_ACT  = (ACP_STD$READBLK, (READVBLK, READLBLK) )
);
```

4.5 I/O Mechanisms

Table 4-2 summarizes the I/O mechanisms that support 64-bit addresses.

Table 4-2 Summary of 64-Bit Support by I/O Mechanism

Mechanism	64-Bits	Comments
Simple buffered I/O	Yes	32/64-bit BUFIO packet headers
Complex Buffered I/O	No	Used by XQP and ACPs
Complex Chained Buffered I/O	Yes	New cells in CXB
Direct I/O	Yes	Cross-process PTE problem
LAN VCI	Yes	Cross-process PTE problem
VMS I/O Cache	Yes	64-bit support is transparent to other components
Buffer Objects	Yes	Special case of direct I/O
Diagnostic buffers	Yes	Driver-wide attribute

Modifying Device Drivers to Support 64-Bit Addressing

4.5 I/O Mechanisms

4.5.1 Simple Buffered I/O

Figure 4–1 shows a 32-bit buffered I/O packet header.

Figure 4–1 32-Bit Buffered I/O Packet Header

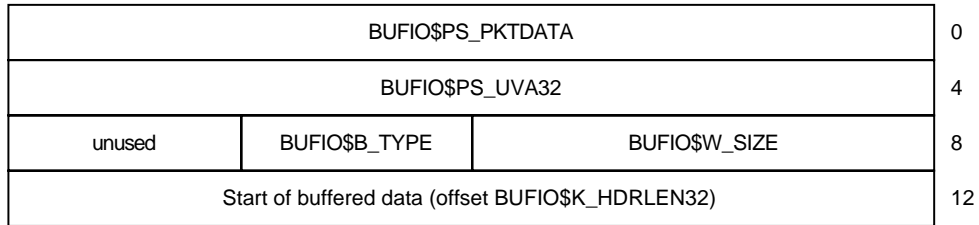

ZK-8203A-GE

BUFIO\$PS_PKTDATA Contains pointer to buffered data in packet

BUFIO\$PS_UVA32 Contains 32-bit user virtual address

- No symbolic offsets currently defined.
- Frequent use of manifest constants; for example:

```
MOVAB 12(R2), (R2)
```

- Dependencies on the packet header layout can be anywhere in the driver code path.
- Drivers allocate and initialize these packets.

A 64-bit buffered packet header is as shown in Figure 4–2.

Figure 4–2 New 64-Bit Buffered I/O Packet Header

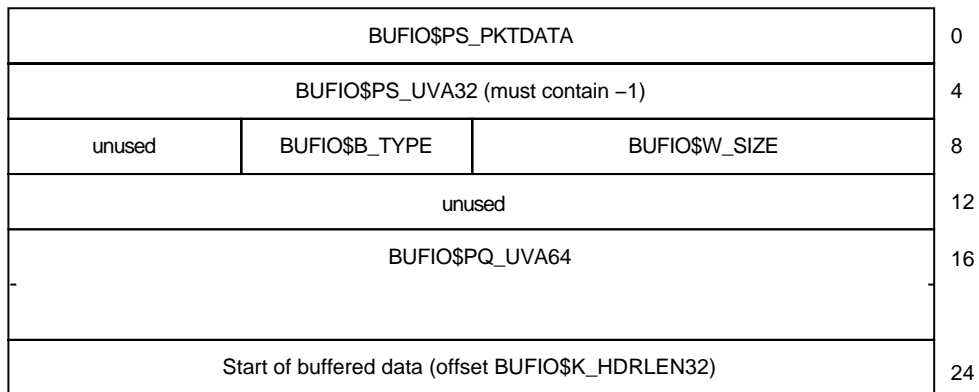

ZK-8204A-GE

Modifying Device Drivers to Support 64-Bit Addressing

4.5 I/O Mechanisms

BUFIO\$PKTDATA	Contains pointer to buffered data in packet
BUFIO\$UVA32	Must contain BUFIO\$K_64 (-1) value
BUFIO\$PQ_UVA64	Contains 64-bit user virtual address

- BUFIO structures and offsets now defined.
- Both 32-bit and 64-bit formats supported.
- BUFIO packets are self-identifying.
- New routines are EXE_\$STD\$ALLOC_BUFIO_64, EXE_\$STD\$ALLOC_BUFIO_32.
- Used for diagnostic buffers as well.

4.5.2 Direct I/O

- The caller's virtual address for the buffer is used only in FDT context.
- Most of the driver identifies buffer start by IRP\$SL_SVAPTE and IRP\$SL_BOFF.
- Driver "layering" in start I/O or fork environments.
- Most drivers use either OpenVMS-supplied upper-level FDT routines or FDT support routines.
- The moving of the page tables has a significant impact:
 1. Only the *current* process's PTEs are available at any given time. This is called the "cross-process PTE access" problem.
 2. A 64-bit address is required to access page table entries in page table space: process, global, and system PTEs.
 3. Because "SVAPTE, BOFF, BCNT" are used in many device drivers, the impact of 1 and 2 is not insignificant.

Modifying Device Drivers to Support 64-Bit Addressing

4.5 I/O Mechanisms

4.5.3 Direct I/O Buffer Map (DIOBM)

Figure 4–3 shows the DIOBM data structure.

Figure 4–3 Direct I/O Buffer Map Data Structure

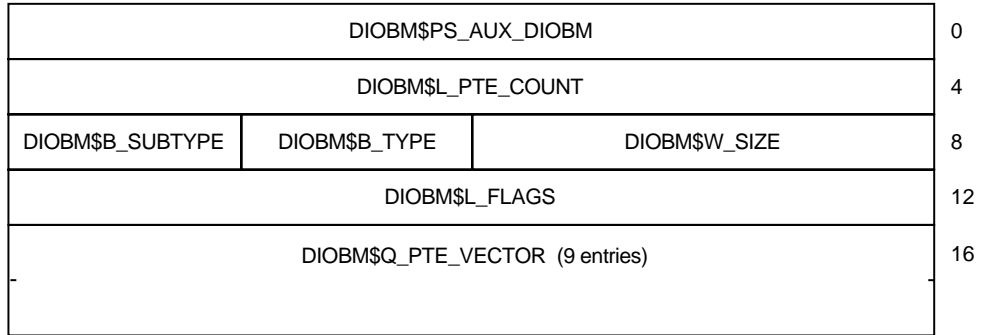

ZK-8205A-GE

- Use PTE vector in DIOBM for buffers up to 64 Kb
- Use "secondary" DIOBM for buffers up to 5.2 Mb
- Use PTE window method with DIOBM for larger buffer
- DIOBM embedded in IRP, IRPE, VCRP, DCBE
- MMG_STD\$IOLOCK_BUF replaces MMG_STD\$IOLOCK
- New DIOBM routines; for example IOC_STD\$FILL_DIOBM
- Also of interest to LAN VCI clients

Modifying Device Drivers to Support 64-Bit Addressing 4.5 I/O Mechanisms

4.5.4 64-Bit AST

Figure 4–4 shows a 64-Bit AST.

Figure 4–4 64-Bit AST

ACB\$L_ASTQFL			0
ACB\$L_ASTQBL			4
ACB\$B_RMOD	ACB\$B_TYPE	ACB\$W_SIZE	8
ACB\$L_PID			12
ACB\$L_AST/ACB\$L_ACB64X			16
ACB\$L_ASTPRM			20
ACB\$L_FLAGS			24
ACB\$L_THREAD_PID			28
ACB\$L_KAST			32
unused			36
ACB64\$PQ_AST			40
ACB64\$Q_ASTPRM			48

ZK-8206A-GE

ACB\$B_RMOD	New ACB\$V_FLAGS_VALID bit (last spare bit)
ACB\$L_FLAGS	Contains ACB\$V_64BITS bit (was filler space)
ACB\$L_ACB64X	Byte offset to ACB64X structure

- Both ACB and ACB64X formats are supported.
- ACB packets are self-identifying.
- An ACB64 is an ACB with an immediate ACB64X.

Modifying Device Drivers to Support 64-Bit Addressing

4.5 I/O Mechanisms

Functions in this category are implemented as direct I/O operations and transfer control information from the caller's buffer to the device driver. The device driver usually interprets the data or uses it to control the operation of the device.

Usually these functions do not support 64-bit addresses. In contrast to the raw data transfers, control data transfers tend to be smaller and are invoked less frequently. Thus, there is less need to be able to store such data in a 64-bit addressable region. The only area impacted in the driver are the corresponding FDT routines. However, control data often introduces the problem of embedded 32-bit pointers.

3. Buffered I/O, raw data transfer

Functions in this category are implemented as buffered I/O operations by the device driver but are otherwise the same type of raw data transfer from the caller's buffer as the first category.

4. Buffered I/O, control data transfer

Functions in this category are implemented as buffered I/O operations by the device driver but are otherwise the same type of control data transfer from the caller's buffer as the second category.

5. Control operation, no data transfer, with parameters

Functions in this category control the device and do not transfer any data between a caller's buffer and the device. Since there is no caller's buffer it does not matter whether the function is designated as a buffered or direct I/O function. The control operation has parameters that are specified in p1 through p6 however these parameters do not point to a buffer.

6. Control operation, no data transfer, with no parameters

Functions in this category control the device and do not transfer any data between a caller's buffer and the device. Since there is no caller's buffer it does not matter whether the function is designated as a buffered or direct I/O function. In addition, there are no parameters for these functions.

Table 4–3 summarizes the I/O functions described in this section.

Table 4–3 Guidelines for 64-Bit Support by I/O Function

Function Type	64-Bits	Area of Impact
Direct I/O, raw data transfer	Yes	FDT only
Direct I/O, control data transfer	No	FDT only
Buffered I/O, raw data transfer	No/yes	Entire driver, new BUFIO packet
Buffered I/O, control data transfer	No	Entire driver, new BUFIO packet
Control, no data transfer, param	No	Entire path but usually simple

(continued on next page)

Modifying Device Drivers to Support 64-Bit Addressing

4.5 I/O Mechanisms

Table 4–3 (Cont.) Guidelines for 64-Bit Support by I/O Function

Function Type	64-Bits	Area of Impact
Control, no data transfer, no params	Moot	None

4.6 64-Bit Support in Example Driver

This section summarizes changes made to the example device driver (LRDRIVER.C) to support 64-bit buffer addresses on all I/O functions.

This sample driver is available in the SYS\$EXAMPLES directory.

1. All functions are declared as capable of supporting a 64-bit P1 parameter.
2. The 64-bit buffered I/O packet header defined by bufiodef.h is used instead of a privately defined structure that corresponds to the 32-bit buffered I/O packet header.
3. The pointer to the caller's set mode buffer is defined as a 64-bit pointer.
4. IRP\$Q_QIO_P1 is used instead of IRP\$L_QIO_P1.
5. The EXE_STD\$ALLOC_BUF_64 routine is used instead of EXE_STD\$DEBIT_BYTCNT_ALO to allocate the buffered I/O packet.

No infrastructure changes were necessary to this driver. The original version could have been simply recompiled and relinked and it would have worked correctly with 32-bit buffer addresses.

4.6.1 Example: Declaring 64-Bit Functions

Original:

```
ini_fdt_act(...,IO$_WRITEBLK,lr$write,BUFFERED);  
...  
ini_fdt_act(...,IO$_SENSECHAR,exe_std$sensemode,  
            BUFFERED);
```

64-Bit Version:

```
ini_fdt_act(...,IO$_WRITEBLK,lr$write,BUFFERED_64); ❶  
ini_fdt_act(...,IO$_WRITEPBLK,lr$write,BUFFERED_64);  
ini_fdt_act(...,IO$_WRITEVBLK,lr$write,BUFFERED_64);  
ini_fdt_act(...,IO$_SETMODE,lr$setmode,BUFFERED_64); ❷  
ini_fdt_act(...,IO$_SETCHAR,lr$setmode,BUFFERED_64);  
ini_fdt_act(...,IO$_SENSEMODE,exe_std$sensemode,  
            BUFFERED_64); ❸  
ini_fdt_act(...,IO$_SENSECHAR,exe_std$sensemode,  
            BUFFERED_64);
```

- ❶ Source changes required to LR\$WRITE routine
- ❷ Source changes required to LR\$SETMODE routine
- ❸ No user buffer, no \$QIO parameters

4.6.2 Example: Declaring 64-Bit Buffered I/O Packet

Original:

```
typedef struct _sysbuf_hdr {           ❶  
    char *pkt_datap;  
    char *usr_bufp;  
    short pkt_size;  
    short :16;  
    SYSBUF_HDR;  
};
```

64-Bit Version:

```
#include <bufio.h>                    ❷
```

- ❶ Locally defined type, SYSBUF_HDR, for a buffered I/O packet header was necessary.
- ❷ The new bufio.h header file defines the BUFIO type, which includes both the 32-bit and 64-bit buffered I/O packet header cells.

4.6.3 Example: Changes to LR\$WRITE

Original:

```
char *qio_bufp;                        ❶  
SYSBUF_HDR *sys_bufp;  
  
qio_bufp = (char *) irp->irp$l_qio_p1;  ❷  
sys_buflen = qio_buflen + sizeof(SYSBUF_HDR);  ❸  
  
status = exe_std$debit_bytcnt_alo(sys_buflen,  ❹  
                                pcb,  
                                &sys_buflen,  
                                (void **) &sys_bufp);  
  
irp->irp$l_svapte = (void *) sys_bufp;  ❺  
irp->irp$l_boff = sys_buflen;  
sys_datap = (char *) sys_bufp + sizeof(SYSBUF_HDR);  ❻
```

- ❶ Define 32-bit pointer to caller's buffer
- ❷ Pointer is initialized using the 32-bit \$QIO P1 value
- ❸ Size of buffered I/O packet includes header size
- ❹ Allocate pool for buffered I/O packet
- ❺ Connect the buffered I/O packet to IRP
- ❻ Compute pointer to data region within packet

64-Bit Version:

```
CHAR_PQ qio_bufp;                      ❶  
BUFIO *sys_bufp;
```

Modifying Device Drivers to Support 64-Bit Addressing

4.6 64-Bit Support in Example Driver

```
gio_bufp = (CHAR_PQ) irp->irp$q_qio_p1; ❷  
sys_buflen = gio_buflen + BUFIO$K_HDRLEN64; ❸  
status = exe_std$alloc_bufio_64(irp, ❹  
                                pcb,  
                                (VOID_PQ) gio_bufp,  
                                sys_buflen);  
sys_bufp = irp->irp$ps_bufio_pkt; ❺  
sys_datap = sys_bufp->bufio$ps_pktdata; ❻
```

- ❶ Define a 64-bit pointer to caller's buffer.
- ❷ Pointer is initialized using the 64-bit \$QIO P1 value. No source changes on references, for example:

```
exe_std$writechk(irp,pcb,ucb,gio_bufp,gio_buflen);  
memcpy (sys_datap, gio_bufp, gio_buflen);
```

- ❸ Size of buffered I/O packet includes 64-bit header size.
- ❹ Allocate pool for a 64-bit buffered I/O packet and connect it to the IRP.
- ❺ Get pointer to the buffered I/O packet.
- ❻ Get pointer to data region within packet.

4.6.4 Example: Changes to LR\$SETMODE

Original:

```
SETMODE_BUF *setmode_bufp; ❶  
setmode_bufp = (SETMODE_BUF *) irp->irp$l_qio_p1; ❷
```

64-Bit Version:

```
#pragma __required_pointer_size __save  
#pragma __required_pointer_size __long ❸  
typedef SETMODE_BUF *SETMODE_BUF_PQ; ❹  
#pragma __required_pointer_size __restore ❺  
SETMODE_BUF_PQ setmode_bufp; ❻  
setmode_bufp = (SETMODE_BUF_PQ) irp->irp$q_qio_p1; ❼
```

- ❶ 32-bit pointer to a SETMODE_BUF.
- ❷ Pointer is initialized using the 32-bit \$QIO P1 value.
- ❸ Change pointer size to 64-bits.
- ❹ Define a type for a 64-bit pointer to a SETMODE_BUF structure.
- ❺ Restore saved pointer size, 32-bits.
- ❻ Define a 64-bit pointer to a SETMODE_BUF structure.
- ❼ Pointer is initialized using the 64-bit \$QIO P1 value.

Modifying Device Drivers to Support 64-Bit Addressing

4.6 64-Bit Support in Example Driver

4.6.5 Example: Changes to LR\$STARTIO

Original:

```
ucb->ucb$r_ucb.ucb$l_svapte =  
    (char *) ucb->ucb$r_ucb.ucb$l_svapte +  
    sizeof(SYSBUF_HDR); ❶
```

64-Bit Version:

```
ucb->ucb$r_ucb.ucb$l_svapte =  
    (char *) ucb->ucb$r_ucb.ucb$l_svapte +  
    BUFIO$K_HDRLLEN64; ❷
```

- ❶** Skip 32-bit buffered I/O packet header.
- ❷** Skip 64-bit buffered I/O packet header.

Modifying User-Written System Services

An application can contain certain routines that perform privileged functions, called **user-written system services**. This chapter describes the OpenVMS Alpha Version 7.0 changes that can affect user-written system services.

For more information about how to create user-written system services, see the *OpenVMS Programming Concepts Manual*.

As part of the 64-bit virtual addressing support, the Alpha system service dispatcher automatically performs a sign-extension check on service arguments to ensure that only 32-bit sign extended virtual addresses are passed. This sign-extension check prevents an application from passing a 64-bit virtual address to system services that are not equipped to handle 64-bit virtual addresses. This sign-extension check occurs for the system services (regardless of mode) provided by Compaq as well as for user-written system services.

Although the sign-extension check occurs by default, it is possible to disable the check for services that can properly handle 64-bit virtual addresses. A new flag, `PLVSM_64_BIT_ARGS` (see Table 5-2), can be specified when creating a user-written system service that is designed to accept 64-bit virtual addresses. The system service dispatcher purposely omits the sign-extension check when this flag is set for a particular service. Table 5-1 shows the components of the Alpha Privileged Library Vector that are new or changed as of OpenVMS Alpha Version 7.0.

Modifying User-Written System Services

Table 5–1 Components of the Alpha Privileged Library Vector

Component	Symbol	Description
User-supplied rundown routine for executive mode services	PLV\$PS_EXEC_RUNDOWN_HANDLER	May contain the address of a user-supplied rundown routine that performs image-specific cleanup and resource deallocation. When the image linked against the user-written system service is run down by the system, this run-time routine is invoked. Unlike exit handlers, the routine is always called when a process or image exits. (Image rundown code calls this routine with a JSB instruction; it returns with an RSB instruction called in executive mode at IPL 0.)
Kernel Routine Flags Vector	PLV\$PS_KERNEL_ROUTINE_FLAGS	Contains either the address of an array of longwords which contain the defined flags associated with each kernel system service, or a zero. Table 5–2 contains a description of the available flags.
Executive Routine Flags Vector	PLV\$PS_EXEC_ROUTINE_FLAGS	Contains either the address of an array of longwords which contain the defined flags associated with each executive mode system service, or a zero. Table 5–2 contains a description of the available flags.

Table 5–2 Flags for 64-Bit User-Written Services

Flag	Description
PLVSM_WAIT_CALLERS_MODE	Informs the system service dispatcher that the service can return the status SSS_WAIT_CALLERS_MODE. This flag can only be specified for kernel mode services.
PLVSM_WAIT_CALLERS_NO_REEXEC	Informs the system service dispatcher that the service can return the status SSS_WAIT_CALLERS_MODE but should not reexecute the service. This flag can only be specified for kernel mode services.
PLVSM_CLRREG	Informs the system service dispatcher to clear the scratch integer registers before returning to the system service requestor. A security-related service may set this flag to ensure that sensitive information is not left in scratch registers. This flag can be specified for both kernel and executive mode system services.
PLVSM_RETURN_ANY	Flags the system service dispatcher that the service can return arbitrary values in R0. This flag can only be specified for kernel mode system services.
PLVSM_WCM_NO_SAVE	Informs the system service dispatcher that the service has taken steps to save the contents of the scratch integer registers. In this case, the dispatcher will not take the extra steps to save and restore these registers. This flag can only be specified for kernel mode system services.
PLVSM_STACK_ARGS	Use of this flag is reserved to Compaq.
PLVSM_THREAD_SAFE	Informs the system service dispatcher that the service requires no explicit synchronization. It is assumed by the dispatcher that the service provides its own internal data synchronization and that multiple kernel threads can safely execute other inner mode code in parallel. This flag can be specified for both kernel and executive mode system services.
PLVSM_64_BIT_ARGS	Informs the system service dispatcher that the service can accept 64-bit virtual addresses. When set, the dispatcher will not perform the sign-extension check on the service arguments. The sign-extension check is the method used to guarantee that only 32-bit, sign-extended virtual addresses are passed to system services. This check is enabled by default. This flag can be specified for both kernel and executive mode system services.
PLVSM_CHECK_UPCALL	Use of this flag is reserved to Compaq.

Example 5–1 illustrates how to create a PLV on Alpha systems using C.

Example 5–1 Creating a Privileged Library Vector (PLV) for C on Alpha Systems

```

/* "Forward routine" declarations */
int    first_service(),
        second_service(),
        third_service(),
        fourth_service();
int    rundown_handler();

```

(continued on next page)

Modifying User-Written System Services

Example 5–1 (Cont.) Creating a Privileged Library Vector (PLV) for C on Alpha Systems

```
/* Kernel and exec routine lists: */
int (*(kernel_table[]))() = {
    first_service,
    second_service,
    fourth_service};

int (*(exec_table[]))() = {
    third_service};

/*
** Kernel and exec flags. The flag settings below enable second_service
** and fourth_service to be 64-bit capable. First_service and third_service
** cannot accept a 64-bit pointer. Attempts to pass 64-bit pointers to
** these services will result in a return status of SS$ARG_GTR_32_BITS.
** The PLV$M_64_BIT_ARGS flag instructs the system service dispatcher to
** bypass sign-extension checking of the service arguments for a particular
** service.
*/
int
    kernel_flags [] = {
        0,
        PLV$M_64_BIT_ARGS,
        0},
    exec_flags [] = {
        PLV$M_64_BIT_ARGS};

/*
** The next two defines allow the kernel and executive routine counts
** to be filled in automatically after lists have been declared for
** kernel and exec mode. They must be placed before the PLV
** declaration and initialization, and for this module will be
** functionally equivalent to:
**
** #define KERNEL_ROUTINE_COUNT 3
** #define EXEC_ROUTINE_COUNT 1
**
*/

#define EXEC_ROUTINE_COUNT sizeof(exec_table)/sizeof(int *)
#define KERNEL_ROUTINE_COUNT sizeof(kernel_table)/sizeof(int *)

/*
** Now build and initialize the PLV structure. Since the PLV must have
** the VEC psect attribute, and must be the first thing in that psect,
** we use the strict external ref-def model which allows us to put the
** PLV structure in its own psect. This is like the globaldef
** extension in VAX C, where you can specify in what psect a global
** symbol may be found; unlike globaldef, it allows the declaration
** itself to be ANSI-compliant. Note that the initialization here
** relies on the change-mode-specific portion (plv$r_cmod_data) of the
** PLV being declared before the portions of the PLV which are specific
** to message vector PLVs (plv$r_msg_data) and system service intercept
** PLVs (plv$r_ssi_data).
**
*/
```

(continued on next page)

Modifying User-Written System Services

Example 5–1 (Cont.) Creating a Privileged Library Vector (PLV) for C on Alpha Systems

```
#ifdef __ALPHA
#pragma extern_model save
#pragma extern_model strict_refdef "USER_SERVICES"
#endif
extern const PLV user_services = {
    PLV$C_TYP_CM0D,          /* type */
    0,                      /* version */
    {
        {KERNEL_ROUTINE_COUNT, /* # of kernel routines */
         EXEC_ROUTINE_COUNT,   /* # of exec routines */
         kernel_table,        /* kernel routine list */
         exec_table,          /* exec routine list */
         rundown_handler,     /* kernel rundown handler */
         rundown_handler,     /* exec rundown handler */
         0,                   /* no RMS dispatcher */
         kernel_flags,        /* kernel routine flags */
         exec_flags}          /* exec routine flags */
    };
#endif
#pragma extern_model restore
#endif
```

Kernel Threads Process Structure

This chapter describes the components that make up a kernel threads process. This chapter contains the following sections:

- Section 6.1 describes the process control block (PCB) and the process header (PHD).
- Section 6.2 describes the kernel thread block (KTB).
- Section 6.3 describes the process identifier (PID).
- Section 6.4 describes the process status bits.

For more information about kernel threads features, see the OpenVMS Alpha Version 7.0 Bookreader version of the *OpenVMS Programming Concepts Manual*.

6.1 Process Control Blocks (PCBs) and Process Headers (PHDs)

Two primary data structures exist in the OpenVMS executive that describe the context of a process:

- Software process control block (PCB)
- Process header (PHD)

The PCB contains fields that identify the process to the system. The PCB comprises contexts that pertain to quotas and limits, scheduling state, privileges, AST queues, and identifiers. In general, any information that must be resident at all times is in the PCB. Therefore, the PCB is allocated from nonpaged pool.

The PHD contains fields that pertain to a process's virtual address space. The PHD consists of the working set list, and the process section table. The PHD also contains the hardware process control block (HWPCB), and a floating point register save area. The HWPCB contains the hardware execution context of the process. The PHD is allocated as part of a balance set slot, and it can be outswapped.

6.1.1 Effect of a Multithreaded Process on the PCB and PHD

With multiple execution contexts within the same process, the multiple threads of execution all share the same address space but have some independent software and hardware context. This change to a multithreaded process impacts the PCB and PHD structures and any code that references them.

Before the implementation of kernel threads, the PCB contained much context that was per process. With the introduction of multiple threads of execution, much context becomes per thread. To accommodate per-thread context, a new data structure—the kernel thread block (KTB)— is created, with the per-thread context removed from the PCB. However, the PCB continues to contain context common to all threads, such as quotas and limits. The new per-kernel thread structure contains the scheduling state, priority, and the AST queues.

Kernel Threads Process Structure

6.1 Process Control Blocks (PCBs) and Process Headers (PHDs)

The PHD contains the HWPCB, which gives a process its single execution context. The HWPCB remains in the PHD; this HWPCB is used by a process when it is first created. This execution context is also called the initial thread. A single threaded process has only this one execution context. Since all threads in a process share the same address space, the PHD continues to describe the entire virtual memory layout of the process.

A new structure, the floating-point registers and execution data (FRED) block, contains the hardware context for newly created kernel threads.

6.2 Kernel Thread Blocks (KTBs)

The kernel thread block (KTB) is a new per-kernel thread data structure. The KTB contains all per-thread context moved from the PCB. The KTB is the basic unit of scheduling, a role previously performed by the PCB, and is the data structure placed in the scheduling state queues. Since the KTB is the logical extension of the PCB, the SCHED spinlock synchronizes access to the KTB and the PCB.

Typically, the number of KTBs a multithreaded process has, matches the number of CPUs on the system. Actually, the number of KTBs is limited by the value of the system parameter MULTITHREAD. If MULTITHREAD is zero, the OpenVMS kernel support is disabled. With kernel threads disabled, user-level threading is still possible with DECThreads. The environment is identical to the OpenVMS environment prior to this release that implements kernel threads. If MULTITHREAD is nonzero, it represents the maximum number of execution contexts or kernel threads that a process can own, including the initial one.

In reality the KTB is not an independent structure from the PCB. Both the PCB and KTB are defined as sparse structures. The fields of the PCB that move to the KTB retain their original PCB offsets in the KTB. In the PCB, these fields are unused. In effect, if the two structures are overlaid, the result is the PCB as it currently exists with new fields appended at the end. The PCB and KTB for the initial thread occupy the same block of nonpaged pool; therefore, the KTB address for the initial thread is the same as for the PCB.

6.2.1 KTB Vector

When a process becomes multithreaded, a vector similar to the PCB vector is created in pool. This vector contains the list of pool addresses for the kernel thread blocks in use by the process. The KTB vector entries are reused as kernel threads are created and deleted. An unused entry contains a zero. The vector entry number is used as a kernel thread ID. The first entry always contains the address of the KTB for the initial thread, which is by definition kernel thread ID zero. The kernel thread ID is used to build unique PIDs for the individual kernel threads. Section 6.3.1 describes PID changes for kernel threads.

To implement these changes, the following four new fields have been added to the PCB:

- PCB\$L_KTBVEC
- PCB\$L_INITIAL_KTB
- PCB\$L_KT_COUNT
- PCB\$L_KT_HIGH

Kernel Threads Process Structure

6.2 Kernel Thread Blocks (KTBs)

The `PCBSL_INITIAL_KTB` field actually overlays the new `KTBSL_PCB` field. For a single threaded process, `PCBSL_KTBVEC` is initialized to contain the address of `PCBSL_INITIAL_KTB`. The `PCBSL_INITIAL_KTB` always contains the address of the initial thread's KTB. As a process transitions from being single threaded to multithreaded and back, `PCBSL_KTBVEC` is updated to point to either the KTB vector in pool or `PCBSL_INITIAL_KTB`.

The `PCBSL_KT_COUNT` field counts the valid entries in the KTB vector. The `PCBSL_KT_HIGH` field gives the highest vector entry number in use.

6.2.2 Floating-Point Registers and Execution Data Blocks (FREDs)

To allow for multiple execution contexts, not only are additional KTBs required to maintain the software context, but additional HWPCBs must be created to maintain the hardware context. Each HWPCB has allocated with it a block of 256 bytes for preserving the contents of the floating-point registers across context switches. Another 128 bytes is allocated for per-kernel thread data. Presently, only a clone of the `PHDSL_FLAGS2` field is defined.

The combined structure that contains the HWPCB, floating-point register save area, and per-kernel thread data is called the floating-point registers and execution data (FRED) block. It is 512 bytes in length. These structures reside in the process's balance set slot. This allows the FREDs to be outswapped with the process header. On the first page allocated for FRED blocks, the first 512 bytes are reserved for the inner-mode semaphore.

6.2.3 Kernel Threads Region

Much process context resides in P1 space, taking the form of data cells and the process stacks. Some of these data cells need to be per-kernel thread, as do the stacks. By calling the appropriate system service, a kernel thread region in P1 space is initialized to contain the per-kernel thread data cells and stacks. The region begins at the boundary between P0 and P1 space at address `40000000x`, and it grows toward higher addresses and the initial thread's user stack. The region is divided into per-kernel thread areas. Each area contains pages for data cells and the four stacks.

6.2.4 Per-Kernel Thread Stacks

A process is created with four stacks; each access mode has one stack. All four of these stacks are located in P1 space. Stack sizes are either fixed, determined by a `SYSGEN` parameter, or expandable. The parameter `KSTACKPAGES` controls the size of the kernel stack. This parameter continues to control all kernel stack sizes, including those created for new execution contexts. The executive stack is a fixed size of two pages; with kernel threads implementation, the executive stack for new execution contexts continues to be two pages in size. The supervisor stack is a fixed size of four pages; with kernel threads implementation, the supervisor stack for new execution contexts is reduced to two pages in size.

For the user stack, a more complex situation exists. OpenVMS allocates P1 space from high to lower addresses. The user stack is placed after the lowest P1 space address allocated. This allows the user stack to expand on demand toward P0 space. With the introduction of multiple sets of stacks, the locations of these stacks impose a limit on the size of each area in which they can reside. With the implementation of kernel threads, the user stack is no longer boundless. The initial user stack remains semiboundless; it still grows toward P0 space, but the limit is the per-kernel thread region instead of P0 space.

Kernel Threads Process Structure

6.2 Kernel Thread Blocks (KTBs)

6.2.5 Per-Kernel Thread Data Cells

Several pages in P1 space contain process state in the form of data cells. A number of these cells must have a per-kernel thread equivalent. These data cells do not all reside on pages with the same protection. Because of this, the per-kernel area reserves approximately two pages for these cells. Each page has a different page protection; one page protection is user read, user write (URUW), the other is user read, executive write (UREW). The top of the user stack is used for the URUW data cells.

6.2.6 Layout of the Per-Kernel Thread

Each per-kernel thread area contains a set of stacks and two pages for data. Each area is a fixed size. For a system using the default values for the kernel stack and user stack size, each area has the layout shown in Figure 6–1.

Figure 6–1 Default Kernel Stack and User Stack Sizes

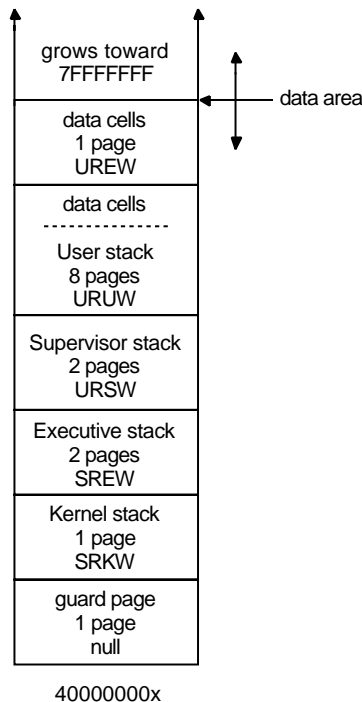

ZK-7926A-GE

6.2.7 Summary of Process Data Structures

Process creation results in a PCB/KTB, a PHD/FRED, and a set of stacks. All processes have a single kernel thread, the initial thread. A multithreaded process always begins as a single threaded process. A multithreaded process contains a PCB/KTB pair and a PHD/FRED pair for the initial thread; for its other threads, it contains additional KTBs, additional FREDs, and additional sets of stacks. When the multithreaded application exists, the process returns to its single threaded state, and all additional KTBs, FREDs, and stacks are deleted.

Kernel Threads Process Structure

6.2 Kernel Thread Blocks (KTBs)

Figure 6–2 Structure of a Multithreaded Process

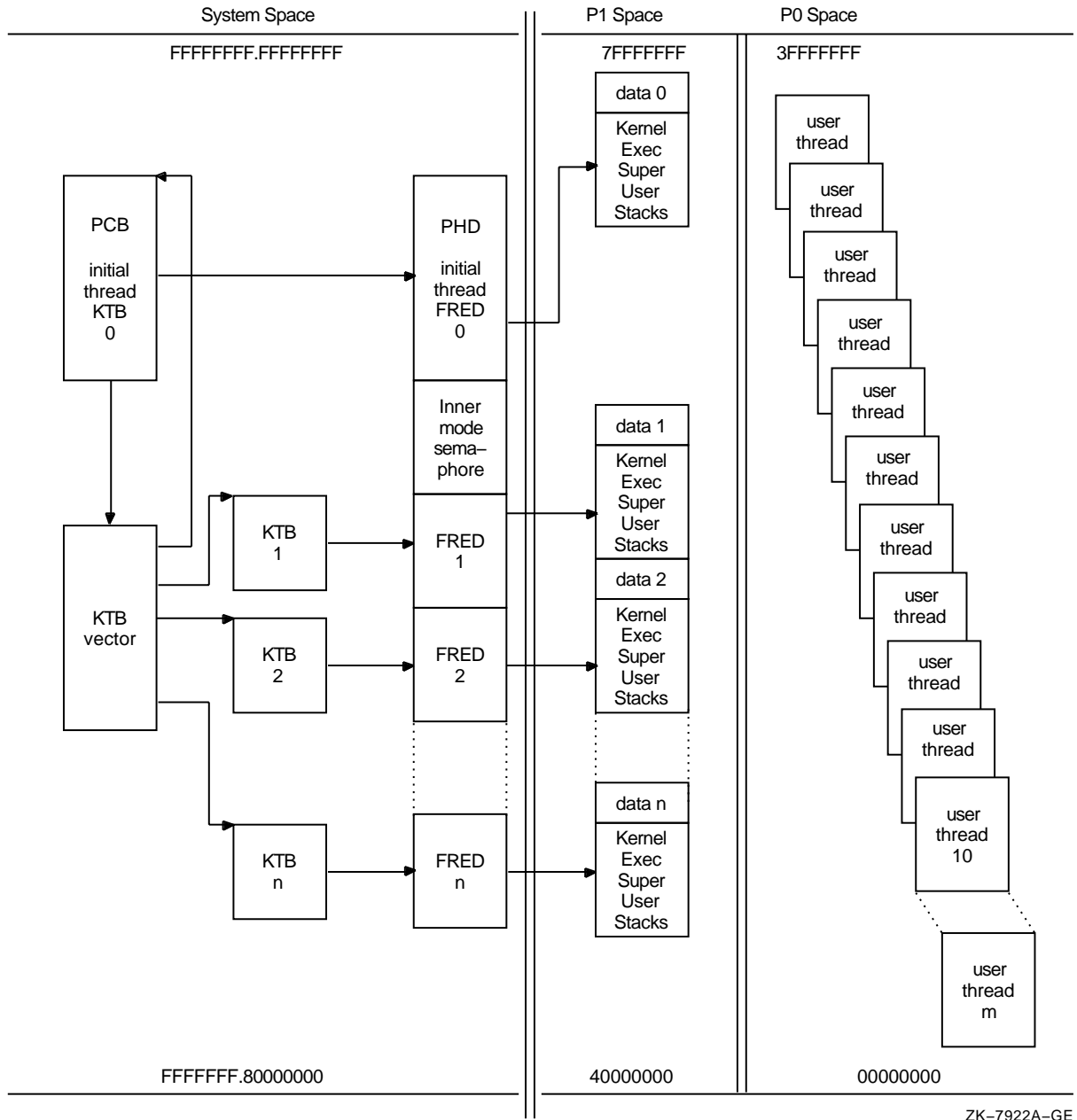

ZK-7922A-GE

Figure 6–2 shows the relationships and locations of the data structures for a process.

6.3 Process Identifiers (PIDs)

OpenVMS qualifies much context by the process ID (PID). With the implementation of kernel threads, much of that process context moves to the thread level. With kernel threads, the basic unit of scheduling is no longer the process but rather the kernel thread. Because of this, kernel threads need a method to identify them which is similar to the PID. To satisfy this need, the meaning of the PID is extended. The PID continues to identify a process, but

Kernel Threads Process Structure

6.3 Process Identifiers (PIDs)

can also identify a kernel thread within that process. An overview follows that presents the features of the PID, and the extended process ID (EPID), which is the cluster-visible extension of the PID.

The PID in this form is typically known as the internal PID (IPID). It consists of two pieces of information, both one word in length. Figure 6–3 shows the layout.

Figure 6–3 Process ID (PID)

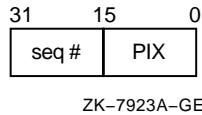

The low word is the process index (PIX). The PIX is used as an index into the PCB vector. This is a vector of PCB addresses. Therefore the PIX gives a quick method of determining the PCB address given a PID.

Another array, also indexed by PIX, contains a sequence number entry for each PIX. The sequence number increments every time a PIX is reused. The high word of the IPID is a copy of the value in the array for a particular PIX. This feature validates a PID to ensure that the ID is not for a process which has been deleted. The sequence number in the IPID must match the one in the sequence number array for that PIX.

The EPID is the cluster-visible PID. It consists of five parts, as Figure 6–4 shows.

Figure 6–4 Extended Process ID (EPID)

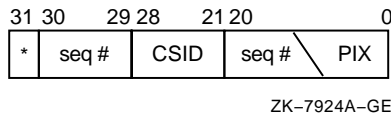

The EPID takes its low 21 bits from the two word IPID fields seen in Figure 6–3. The value of MAXPROCESSCNT determines the number of bits within the 21 bits used for the PIX (5 to 13 bits). The sequence number uses the remaining bits (8 to 16 bits). The PIX cannot be larger than 8192; the sequence number no larger than 32767. If the system is an OpenVMS cluster member, the next 10 bits of the EPID uniquely identify the PID within the cluster. They contain 8 bits of the cluster system ID (CSID) for the system, and a 2 bit sequence number. The system service SYSSGETJPI uses the high bit (31). If set, the bit specifies that the PID is a wildcard context value. This allows collecting information for all processes in the system.

6.3.1 Multithread Effects on the PID

With kernel threads implementation, the PID's definition undergoes two changes:

- MAXPROCESSCNT's maximum value is increased to 16,384.
To do this, the maximum PIX field width for the EPID is increased by one bit. This results in shrinking the sequence number field by one bit.
- A redefinition of the sequence number.

The redefinition of the usage of the sequence number results in it taking on a dual meaning. It continues to be used to validate a PID; it also becomes the means for determining the kernel thread ID. Instead of a single sequence number being assigned to a PIX, a range of sequence numbers are used, one for each kernel thread. Therefore, the format of a kernel thread PID is identical to that of the PID in either its IPID, or EPID representation. The PIX and sequence number fields are in the same location, and they are the same size. In the EPID, the 10 bits used to uniquely identify the PID within the cluster remain the same; this enables kernel threads to be visible clusterwide.

6.3.2 Range Checking and Sequence Vectors

Every process has at least one kernel thread, the initial thread, which is always thread ID zero; therefore, given a particular PID, the PIX continues to be used as an index into the PCB and sequence vectors. A range check validates the sequence numbers.

Before kernel threads implementation, the sequence number vector (SCH\$GL_SEQVEC) was a vector of words. After kernel threads implementation, it is a vector of longwords that enables range checking for sequence number validation. The low word in each longword is the base sequence number for a particular PIX, and the upper word is the next sequence number for that PIX. The sequence number for a single-threaded process must be equal to the base value. Kernel threads PID sequence numbers must fall within the base and next values.

Figure 6-5 shows the flow of range checking of sequence numbers.

Figure 6-5 Range Checking and Sequence Vectors

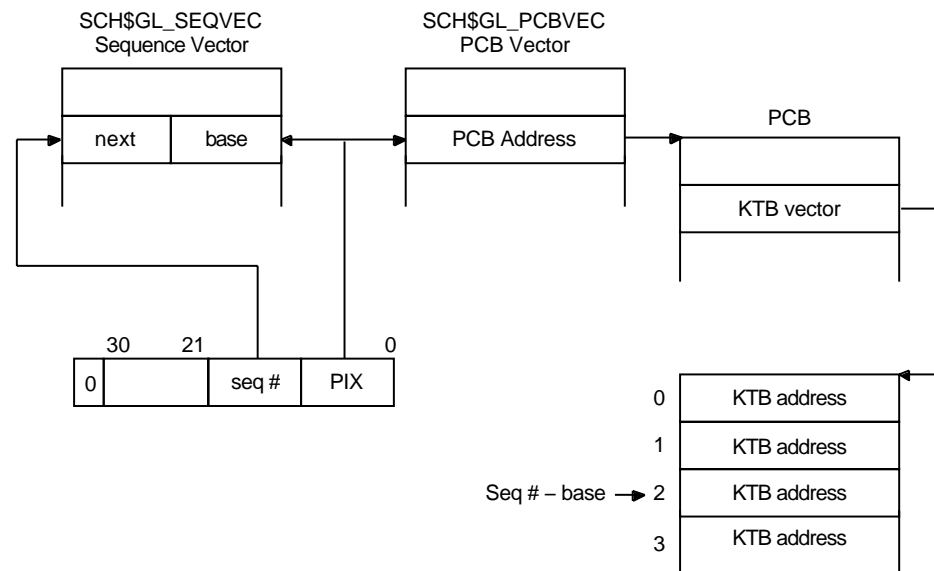

ZK-7925A-GE

Kernel Threads Process Structure

6.4 Process Status Bits

6.4 Process Status Bits

Similar to the fields in the PCB that migrate to the KTB, there are several status bits that need to be per thread. The interface for the SYSS\$GETJPI and SYSS\$PROCESS_SCAN system services indicates that the entire longword fields that contain the status bits can be returned. Therefore, all the status bits must remain defined as they are. The PCB specific bits are “reserved” in the KTB structure definition. Likewise, the KTB specific bits are “reserved” in the PCB. Because the PCB is really an overlaid structure with the initial thread’s KTB, just the PCB status bits need to be returned for the initial thread. The status longword returned for other threads is built by first masking out the initial thread’s bits, and then OR’ing the remainder with the status longword in the appropriate KTB.

If a thread in a multithreaded process requests information about itself using SYSS\$GETJPI (passes PID=0), then the status bits for the kernel thread it is running on are returned. Since each kernel thread has its own PID, SYSS\$GETJPI can be called for each of the kernel threads in a process. The return status bits are the combination of the PCB status bits and those in the KTB associated with the input PID.

Data Structure Changes

This appendix contains descriptions of the OpenVMS Alpha Version 7.0 I/O data structure changes made to support 64-bit addressing.

The data structures are listed in alphabetical order. However, the individual structure members are listed in the order in which they are defined within each data structure. Note, however, that the following sections only describe new or changed structure members. Existing unchanged members are not described. In addition, unused or “fill” structure members that might be added to obtain natural alignment are not listed. Thus, you can not use the following descriptions to calculate the precise memory layout of the structures. However, you can assume that any new or changed structure members will be naturally aligned within the structure.

A.1 Pointer Size Conventions

Any unqualified use of the term “pointer” implies a 32-bit pointer. All 64-bit pointers will be explicitly identified as either a 64-bit or quadword pointer.

As of OpenVMS Alpha Version 7.0, a new C compiler pragma controls the pointer size. To facilitate the use of 64-bit pointers, a new header file, `far_pointers.h` in `SYSS$STARLET_C.TLB`, defines types for 64-bit pointers to the intrinsic C data types.

Table A-1 summarizes the 64-bit pointer data types.

Table A-1 64-Bit Pointer Data Types

Type Name	32-Bit Analog	Description	Defined by
CHAR_PQ	char *	64-bit pointer to a char	far_pointers.h
CHAR_PPQ	char **	64-bit pointer to a CHAR_PQ	far_pointers.h
INT_PQ	int *	64-bit pointer to a 32-bit int	far_pointers.h
INT64_PQ	int64 *	64-bit pointer to a 64-bit int	far_pointers.h
UINT64_PQ	uint64 *	64-bit pointer to a 64-bit int	far_pointers.h
VOID_PQ	void *	64-bit pointer to arbitrary data	far_pointers.h
VOID_PPQ	void **	64-bit pointer to a VOID_PQ	far_pointers.h
IOSB_PQ	IOSB *	64-bit pointer to an IOSB structure	iosbdef.h
IOSB_PPQ	IOSB **	64-bit pointer to an IOSB_PQ	iosbdef.h
PTE_PQ	PTE *	64-bit pointer to a PTE	ptedef.h

(continued on next page)

Data Structure Changes

A.1 Pointer Size Conventions

Table A–1 (Cont.) 64-Bit Pointer Data Types

Type Name	32-Bit Analog	Description	Defined by
PTE_PPQ	PTE **	64-bit pointer to a PTE_PQ	ptedef.h

A.2 Buffer Object Descriptor (BOD)

This section describes the additions and changes to cells in the buffer object descriptor (BOD) structure (see Table A–2).

Table A–2 BOD Structure Changes

Field	Type	Comments
bod\$ <i>v</i> _s2_window	Bit	A bit equal to BOD\$M_S2_WINDOW in the bod\$1_flags cell. When this bit is clear, the buffer object is mapped into the S0/S1 portion of system space and the bod\$ps_svapte and bod\$1_basesva cells are valid. When this bit is set, the buffer object is mapped into the S2 portion of system space and the bod\$ <i>pq</i> _va_pte and bod\$ <i>pq</i> _basesva cells are valid.
bod\$ <i>pq</i> _basepva	VOID_PQ	Process virtual address for the start of the buffer object. This cell replaces the bod\$1_basepva cell.
bod\$1_basepva	-	This cell will be removed. It will be replaced by the bod\$ <i>pq</i> _basepva cell.
bod\$ <i>pq</i> _basesva	VOID_PQ	System virtual address for the start of the buffer object. This cell is overlaid on the bod\$1_basesva cell and this use is valid only if BOD\$M_S2_WINDOW is set in bod\$1_flags.
bod\$ <i>pq</i> _va_pte	PTE_PQ	Virtual address for the first system PTE that maps the buffer object. This cell is overlaid on the bod\$ps_svapte cell and this use is valid only if BOD\$M_S2_WINDOW is set in bod\$1_flags.

A.3 Buffered I/O (BUFIO)

The existing 32-bit Buffered I/O (BUFIO) packet format will continue to be supported. In addition, a new 64-bit BUFIO packet format will be supported. These BUFIO packets are “self identifying”. That is, it is possible to distinguish a 32-bit from a 64-bit format BUFIO packet from information in the packet.

Although the structure type code DYN\$C_BUFIO is defined and there is an expected layout for the header of buffered I/O packet, there currently is no formal definition of a structure. Existing code in drivers and IOCIOPST.MAR uses numeric constants as offsets.

The existing 32-bit BUFIO packet will be formally defined along with a new 64-bit BUFIO packet format. The 64-bit BUFIO structure format will also be used for 64-bit diagnostic buffer packets (see Table A-3).

Table A-3 BUFIO Packet

Field	Type	Comments
bufio\$ps_pktdata	void *	Pointer to the buffered data within the packet.
bufio\$ps_uva32	void *	32-bit pointer to user's address space. On a read function, data is transferred from that user virtual address to the buffer packet during FDT processing. On a write function, data is transferred to that user virtual address from the buffer packet during I/O Postprocessing. If this cell contains the value BUFIO\$K_64 (-1), then the pointer to the user buffer is in bufio\$pq_uva64.
bufio\$w_size	unsigned short	Size of the BUFIO packet in bytes.
bufio\$b_type	unsigned char	Nonpaged pool packet type code, DYN\$C_BUFIO
BUFIO\$K_HDRLEN32	constant	Size in bytes of the minimal buffered I/O packet header with a 32-bit user virtual address (12).
bufio\$pq_uva64	VOID_PQ	64-bit pointer to user's address space. On a read function, data is transferred from that user virtual address to the buffer packet during FDT processing. On a write function, data is transferred to that user virtual address from the buffer packet during I/O Postprocessing. This cell contains a valid address only if the bufio\$ps_uva32 cell contains the value BUFIO\$K_64 (-1).
BUFIO\$K_HDRLEN64	constant	Size in bytes of the minimal buffered I/O packet header with a 64-bit user virtual address (24).

A.4 Complex Chained Buffer (CXB)

The CXB structure defines the format of entries that are linked together to build a complex chained buffered I/O packet.

The CXB structure will be enhanced such that it can be used by existing code with no source changes to support a 32-bit caller's buffer address. However, the same enhanced CXB structure can be used to support a 64-bit caller's buffer address as well (see Table A-4).

Data Structure Changes

A.4 Complex Chained Buffer (CXB)

Table A-4 CXB Structure Changes

Field	Type	Comments
cxb\$ps_pktdata	void *	Pointer to the buffered data within the packet. This cell will be overlaid on the existing cxb\$1_fl cell to reflect its current alternate use.
cxb\$ps_uva32	void *	32-bit pointer to user's address space. If this cell contains the value BUFIO\$K_64 (-1) then the pointer to the user buffer is in cxb\$pq_uva64. This cell will be overlaid on the existing cxb\$1_b1 cell to reflect its current alternate use.
cxb\$pq_uva64	VOID_PQ	64-bit pointer to user's address space. This cell contains a valid address only if the cxb\$ps_uva32 cell contains the value BUFIO\$K_64 (-1). This cell will be inserted as the last aligned quadword just before the end of the standard CXB header which is CXB\$K_LENGTH bytes long.

A.5 Data Chain Block (DCBE)

The DCBE structure is the Data Chain Block that is used by the OpenVMS LAN driver VMS Communications Interface (VCI). A DCBE is used to connect to a VCRP all or part of the data to be transmitted. A chain of DCBEs is used when the data is contained in more than one discontinuous buffer in virtual memory.¹

There are two mutually exclusive methods that a DCBE can use to identify the start of the buffer:

1. When the dcbe\$1_buffer_address cell contains a zero, the buffer address is specified by the dcbe\$1_svapte and dcbe\$1_boff cells. A fixed-size primary DIOBM structure will be added to the DCBE. This embedded DIOBM structure is available for use by an upper-level VCM if it needs to derive a 32-bit SVAPTE from a 64-bit VA_PTE for the PTEs that map the buffer. The lower-level VCM will not alter this embedded DIOBM or make any assumptions about it.
2. When the dcbe\$1_buffer_address cell contains a non-zero value, this value is the system virtual address of the buffer. This method remains unchanged.

Because a VCRP can also be used as a DCBE, the named DCBE cells must be at the same offsets as their VCRP counterparts. Therefore, DCBE changes are reflected in the VCRP and changes to the common portion of the VCRP are reflected in the DCBE.

In addition, SYSSPEDRIVER overlays a DCBE with the vcrp\$t_internal_stack area within the VCRP. Therefore, an increase in the size of the DCBE must be reflected by a corresponding increase in the size of the internal stack area within the VCRP (see Table A-5).

¹ The DCBE should not be confused with the similarly named DCB structure. The DCB is used internally by the DECnet Phase IV NETDRIVER. As described in Section 2.2.3, the dcbe\$1_svapte cell value will be derived from the irp\$1_svapte cell in the associated IRP and will rely on the DIOBM that is embedded in the IRP. For this reason there is no need for an embedded DIOBM in the DCB structure.

Table A–5 DCBE Structure Changes

Field	Type	Comments
dcbe\$l_reserved	int32[13]	This existing vector of 6 filler longwords has been increased to 13 fill longwords to reflect the increased size of the common portion of the VCRP. The common portion of the VCRP has been increased to accommodate either an ACB64 or ACB structure.
dcbe\$pq_buffer_addr64	VOID_PQ	64-bit buffer address. This cell is available for use by upper-level VCMs only. Note that this cell does not replace the dcbe\$l_buffer_address cell which continues to be used by lower-level VCMs. The dcbe\$pq_buffer_addr64 cell has been added after the dcbe\$l_bcnc cell.
dcbe\$r_diobm	DIOBM	Embedded fixed-size primary "direct I/O buffer map" structure. This DIOBM structure is available for use by upper-level VCMs that need to lock down a buffer and provide a value for the dcbe\$l_svapte cell. This structure has been added just before the end of the DCBE header.

A.6 Direct I/O Buffer Map (DIOBM)

The Direct I/O Buffer Map (DIOBM) is a new structure that is used to solve the "cross-process PTE problem" for buffers that have been locked into memory for direct I/O.

There are two variants of the DIOBM structure. The first is the primary DIOBM structure. The primary DIOBM structure can be used in the following mutually exclusive ways:

1. To contain copies of the actual PTEs that map the buffer.
2. To point to a larger secondary DIOBM structure if the primary DIOBM structure has insufficient room for all the PTEs that map the user buffer.
3. To manage a PTE window in S0/S1 space onto the actual PTEs that map the buffer if the required PTE count exceeds the capacity of the largest allowable DIOBM structure.

Each of these methods yields a 32-bit system virtual address for the PTEs that map the buffer. This address is valid regardless of process or system context.

The fixed-size DIOBM structure contains room for exactly DIOBM\$K_PTECNT_FIX (9) PTEs and is 88 bytes long. Most primary DIOBM structures are fixed-sized and embedded in other structures. For example, the IRP, IRPE, VCRP, and DCBE structures all contain an embedded fixed-sized primary DIOBM structure.

A secondary DIOBM structure can have room for up to ioc\$gl_diobm_ptecnt_max PTEs and is used only for PTE copies.

Although the offsets and types for both the primary and secondary DIOBM structures are identical, for clarity, they are described in separate tables (see Table A–6 and Table A–7).

Data Structure Changes

A.6 Direct I/O Buffer Map (DIOBM)

Table A–6 Primary DIOBM Structure

Field	Type	Comments
diobm\$ps_aux_diobm	DIOBM *	This is a pointer to a secondary DIOBM structure that is valid if and only if DIOBMSM_AUX_INUSE in diobm\$l_flags is set. The secondary DIOBM structure contains copies of the PTE that map the buffer. When a secondary DIOBM is used, the only use for the primary DIOBM is to locate the secondary.
diobm\$l_pte_count	unsigned int	If DIOBMSM_PTE_WINDOW is clear in diobm\$l_flags, this cell contains the count of PTEs that have been copied to the PTE vector diobm\$q_pte_vector in this DIOBM structure. If DIOBMSM_PTE_WINDOW is set in diobm\$l_flags, this cell contains the count of SPTEs that have been allocated for a PTE window in S0/S1 space to the actual PTEs that map the buffer.
diobm\$w_size	unsigned short	Size of the DIOBM packet in bytes.
diobm\$b_type	unsigned char	Nonpaged pool packet type code, DYN\$C_MISC
diobm\$b_subtype	unsigned char	Nonpaged pool packet subtype code, new DYN\$C_MISC subtype code DYN\$C_DIOBM
diobm\$l_flags	unsigned int	Flag bits.
diobm\$v_rel_dealloc	bit	A bit equal to DIOBMSM_REL_DEALLOC in the diobm\$l_flags cell. If set, routine IOC_STD\$RELEASE_DIOBM deallocates this DIOBM structure. The routine IOC_STD\$FILL_DIOBM sets this bit on any secondary DIOBM structure that it may allocate. The routine IOC_STD\$CREATE_DIOBM sets this bit on the primary DIOBM structure that it allocates.
diobm\$v_pte_window	bit	A bit equal to DIOBMSM_PTE_WINDOW in the diobm\$l_flags cell. This bit is set if the direct I/O buffer is too large for a DIOBM packet (the buffer requires more than ioc\$gl_diobm_ptecnt_max PTEs) and a window in S0 to its PTEs has been allocated. When this bit is set, diobm\$l_pte_count contains the count of SPTEs that have been allocated and the diobm\$l_ptew_sva cell contains the system virtual address that is mapped by the first SPTE allocated for the PTE window. This bit must be clear if diobm\$v_aux_inuse is set.

(continued on next page)

Data Structure Changes

A.6 Direct I/O Buffer Map (DIOBM)

Table A–6 (Cont.) Primary DIOBM Structure

Field	Type	Comments
diobm\$ <i>v_</i> aux_inuse	bit	A bit equal to DIOBMSM_AUX_INUSE in the diobm\$l_flags cell. The diobm\$ps_aux_diobm cell contains a pointer to a secondary DIOBM structure if and only if the diobm\$ <i>v_</i> aux_inuse bit is set. This bit must be clear if diobm\$ <i>v_</i> pte_window is set.
diobm\$ <i>v_</i> inuse	bit	A bit equal to DIOBMSM_INUSE in the diobm\$l_flags cell. This flag is an aid to detecting improper use of DIOBM structures and is used only by the full-checking versions of the routines in the IO_ROUTINES_MON.EXE execlt. This flag is set by the IOC_STDS\$FILL_DIOBM and IOC_STDS\$CREATE_DIOBM routines and is cleared by the IOC_STDS\$RELEASE_DIOBM routine. Prior to setting the flag, the IOC_STDS\$FILL_DIOBM routine checks this flag if the diobm\$b_type cell contains the DYN\$C_MISC value and diobm\$b_subtype contains DYN\$C_DIOBM. If the diobm\$ <i>v_</i> inuse flag is set under these conditions, the IOC_STDS\$FILL_DIOBM routine declares a INCONSTATE bugcheck.
diobm\$ <i>v_</i> s0pte_window	bit	A bit equal to DIOBMSM_S0PTE_WINDOW in the diobm\$l_flags cell. This bit is set if the S0/S1 PTE window was used to derive a 32-bit PTE address for this buffer. When this bit is set the diobm\$ <i>v_</i> pte_window and diobm\$ <i>v_</i> aux_inuse flags must be clear and the diobm\$l_pte_count cell must contain 0.
DIOBM\$K_HDRLEN	constant	Size in bytes of the minimal DIOBM packet header excluding the PTE vector. This is equal to the byte offset of the diobm\$q_pte_vector[0] cell (16).
diobm\$q_pte_vector	PTE[diobm\$l_pte_count]	Vector of diobm\$l_pte_count quadword PTEs that are copies of the PTEs that map the buffer that has been locked for direct I/O. This vector is valid only if both DIOBMSM_AUX_INUSE and DIOBMSM_PTE_WINDOW in diobm\$l_flags are clear.
DIOBM\$K_PTECNT_FIX	constant	This constant specifies the number of PTE entries (9) that fit into the PTE vector in a fix-sized DIOBM structure.
DIOBM\$K_PTECNT_MAX_UNI	constant	This constant specifies the number of PTE entries (94) that fit into the PTE vector in the largest allowable DIOBM structure on an uniprocessor system.
DIOBM\$K_PTECNT_MAX_SMP	constant	This constant specifies the number of PTE entries (430) that fit into the PTE vector in the largest allowable DIOBM structure on an SMP system.

(continued on next page)

Data Structure Changes

A.6 Direct I/O Buffer Map (DIOBM)

Table A–6 (Cont.) Primary DIOBM Structure

Field	Type	Comments
diobm\$ps_ptew_sva	void *	The lowest S0/S1 space virtual address that is mapped by the PTEs that have been allocated for the window onto the direct I/O buffer PTEs. This cell is used to deallocate the PTE window. This cell is overlaid on a portion of diobm\$q_pte_vector since its use is mutually exclusive. This cell is valid if and only if DIOBM\$M_PTE_WINDOW in diobm\$l_flags is set.
DIOBM\$M_NORESWAIT	constant	This is an option bit mask for the flags parameter to the IOC_STDSFILL_DIOBM and IOC_STDSCREATE_DIOBM routines. When this option bit is set and there are insufficient resources for the needs of these routines an error status is returned to their callers instead of putting the process into a resource wait state.

Table A–7 Secondary DIOBM Structure

Field	Type	Comments
diobm\$ps_aux_diobm	DIOBM *	This cell must be zero in a secondary DIOBM structure.
diobm\$l_pte_count	unsigned int	Contains the number of PTEs that can fit into the diobm\$q_pte_vector in this DIOBM structure.
diobm\$w_size	unsigned short	Size of the DIOBM packet in bytes.
diobm\$b_type	unsigned char	Nonpaged pool packet type code, DYN\$C_MISC
diobm\$b_subtype	unsigned char	Nonpaged pool packet subtype code, new DYN\$C_MISC subtype code DYN\$C_DIOBM
diobm\$l_flags	unsigned int	Flag bits.
diobm\$sv_rel_dealloc	bit	A bit equal to DIOBM\$M_REL_DEALLOC in the diobm\$l_flags cell. If set, routine IOC_STDSRELEASE_DIOBM deallocates this DIOBM structure.
diobm\$sv_pte_window	bit	A bit equal to DIOBM\$M_PTE_WINDOW in the diobm\$l_flags cell. This bit must be clear in a secondary DIOBM structure.
diobm\$sv_aux_inuse	bit	A bit equal to DIOBM\$M_AUX_INUSE in the diobm\$l_flags cell. This bit must be clear in a secondary DIOBM structure.
diobm\$sv_s0pte_window	bit	A bit equal to DIOBM\$M_S0PTE_WINDOW in the diobm\$l_flags cell. This bit must be clear in a secondary DIOBM structure.

(continued on next page)

Table A–7 (Cont.) Secondary DIOBM Structure

Field	Type	Comments
diobm\$ <i>q_</i> pte_vector	PTE[diobm\$ <i>l_</i> pte_count]	Vector of diobm\$ <i>l_</i> pte_count quadword PTEs that are copies of the PTEs that map the buffer that has been locked for direct I/O.

A.7 Function Decision Table (FDT)

This section describes the additions to the driver Function Decision Table (FDT) structure (see Table A–8).

Table A–8 FDT Structure Changes

Field	Type	Comments
fdt\$ <i>q_</i> ok64bit	unsigned int64	A 64-bit mask corresponding to the 64 possible I/O function codes. The corresponding bit is set if the function supports a 64-bit \$QIO <i>p1</i> parameter value. This cell is initialized to zero by the MACRO-32 macro FDT_INI, the BLISS macro FDTAB, and in the prototype FDT, DRIVERSFDT, which is used by drivers written in C. This cell has been added to the end of the existing FDT structure.

A.8 I/O Request Packet (IRP)

This section describes the additions and changes to cells in the I/O Request Packet (IRP) structure. The significant IRP changes are:

1. The IRP resembles a 64-bit capable ACB64 structure instead of the existing ACB structure.
2. A fixed-size primary DIOBM is embedded in the IRP for use in deriving a 32-bit system virtual address for the PTEs that map a buffer locked into memory for direct I/O.
3. The IRP cells that contain copies of the 64-bit \$QIO parameter values and the caller's IOSB address have been expanded from 32-bits to 64-bits.
4. Any cells overlaid on the irp\$*l_*ast, irp\$*l_*astprm, or irp\$*l_*iosb cells move to the low-order longword of their quadword replacements.
5. Alternative cell names have been defined for the ast, astprm, and iosb cells that can be used for arbitrary parameters in internal IRPs.

The size of an IRP has increased by 160 bytes (43%), from 376 to 536 bytes (see Table A–9).

Data Structure Changes

A.8 I/O Request Packet (IRP)

Table A–9 IRP Changes

Field	Type	Comments
irp\$b_mode	unsigned char	This is an existing cell in the IRP that contains the caller's mode in the low-order 2 bits. The irp\$l_acb_flags cell is considered valid by SCH\$QAST if and only if ACB\$M_FLAGS_VALID mask is set in this cell. The ACB\$M_FLAGS_VALID mask is always set in this cell by EXE\$QIO when the IRP is allocated.
irp\$l_acb64x_offset	int	Offset to the ACB64X structure embedded in this IRP. This cell is considered valid by SCH\$QAST if and only if ACB\$M_64BITS is set in the irp\$l_acb_flags cell. This cell is initialized to the offset value of the irp\$pq_acb64_ast field. This cell corresponds to the acb64\$l_acb64x cell. Because this cell is at the same offset as the acb\$l_ast cell, the irp\$l_ast cell has been removed.
irp\$l_acb_flags	unsigned int	This cell has been initialized to the mask value ACB\$M_64BITS to indicate that the irp\$l_acb64x_offset field contains an offset to the ACB64X structure. Corresponds to the acb\$l_flags cell.
irp\$l_thread_pid	int	Corresponds to the acb\$l_thread_pid cell. Reserved for use by the Kernel Threads project.
irp\$pq_acb64_ast	VOID_FUNC_PQ	This cell corresponds to the acb64\$pq_ast cell and replaces the irp\$l_ast cell.
irp\$l_ast	-	This cell has been removed. It has been replaced by the irp\$pq_acb64_ast cell.
irp\$l_shd_iofl	IRP *	This is an existing cell that contains the link to the cloned shadowing IRPs. This cell was overlaid on irp\$l_ast and is now overlaid on the low-order longword of the irp\$pq_acb64_ast cell.
irp\$l_iirp_p0	int	Generic parameter cell that is available in internal IRPs. This cell overlays the low-order longword of the irp\$pq_acb64_ast cell and is intended for use by components that use the irp\$l_ast cell for this purpose.
irp\$q_acb64_astprm	int64	This cell corresponds to the acb64\$q_astprm cell and replaces the irp\$l_astprm cell.
irp\$l_astprm	-	This cell has been removed. It is replaced by the irp\$q_acb64_astprm cell.
irp\$l_shad	SHAD *	This is an existing cell in IRPs cloned by shadowing that points to the SHAD structure. This cell was overlaid on irp\$l_astprm and is now overlaid on the low-order longword of the irp\$q_acb64_astprm cell.

(continued on next page)

Data Structure Changes A.8 I/O Request Packet (IRP)

Table A–9 (Cont.) IRP Changes

Field	Type	Comments
irp\$l_hrb	HRB *	This is an existing cell in MSCP server IRPs that points to a Host Request Block structure. This cell was overlaid on irp\$l_astprm and is now overlaid on the low-order longword of the irp\$q_acb64_astprm cell.
irp\$l_mv_tmo	int	This cell is used in internal mount verification IRPs to contain the timeout value. This cell overlays the low-order longword of the irp\$q_acb64_astprm cell and is intended for use by components that currently use the irp\$l_astprm cell for this purpose.
irp\$l_iirp_p1	int	Generic parameter cell that is available in internal IRPs. This cell overlays the low-order longword of the irp\$q_acb64_astprm cell and is intended for use by components that use the irp\$l_astprm cell for this purpose.
irp\$q_user_thread_id	uint64	Unique user thread identifier. Corresponds to the acb64\$q_user_thread_id cell. Reserved for use by the Kernel Threads project.
irp\$pq_iosb	VOID_PQ	64-bit pointer to the caller's IOSB. This cell replaces irp\$l_iosb.
irp\$l_iosb	-	This cell has been removed. It is replaced by the irp\$pq_iosb cell.
irp\$l_cln_wle	unsigned int	This is an existing cell that contains the shadowing write log state. This cell was overlaid on irp\$l_iosb and is now overlaid on the low-order longword of the irp\$pq_iosb cell.
irp\$l_iirp_p2	int	Generic parameter cell that is available in internal IRPs. This cell overlays the low-order longword of the irp\$pq_iosb cell and is intended for use by components that use the irp\$l_iosb cell for this purpose.
irp\$pq_va_pte	PTE_PQ	A 64-bit pointer to the actual PTEs that map the user buffer. If the user buffer is not in shared system space, then this PTE virtual address is only valid in the caller's process context.

(continued on next page)

Data Structure Changes

A.8 I/O Request Packet (IRP)

Table A–9 (Cont.) IRP Changes

Field	Type	Comments
irp\$l_svapte	PTE *	A 32-bit pointer to PTE values that map the user buffer. The PTE values may be copies of the actual PTEs in Page Table Space that map the user buffer. If zero, then no PTEs have been locked for this request. Note that for compatibility with existing drivers, this cell remains overlaid on irp\$ps_bufio_pkt and this use is valid only if IRPSM_BUFIO is clear in irp\$l_sts. Note also that this cell contains a pointer into the CPT structure if IRPSM_CACHEIO is set in irp\$l_sts2.
irp\$ps_bufio_pkt	BUFIO *	Pointer for the buffered I/O packet for this request. If zero, then no packet has been allocated for this request. Note that for compatibility with existing drivers, this cell remains overlaid on irp\$l_svapte and this use is valid only if IRPSM_BUFIO is set in irp\$l_sts.
irp\$r_diobm	DIOBM	Embedded fixed-size primary "direct I/O buffer map" structure. This embedded DIOBM structure is valid if and only if irp\$l_svapte points to a set of PTEs whose pages have been locked down for direct I/O. Specifically, the DIOBM is in use when both IRPSM_BUFIO and IRPSM_CACHEIO in irp\$l_sts are clear and the irp\$l_svapte cell contains a non-zero value. See Section A.6 for a complete description of the DIOBM structure.
irp\$q_qio_p1	int64	Copy of device dependent \$QIO parameter p1. The low order 32-bits of this cell remain accessible via irp\$l_qio_p1.
irp\$q_qio_p2	int64	Copy of device dependent \$QIO parameter p2. The low order 32-bits of this cell remain accessible via irp\$l_qio_p2.
irp\$q_qio_p3	int64	Copy of device dependent \$QIO parameter p3. The low order 32-bits of this cell remain accessible via irp\$l_qio_p3.
irp\$q_qio_p4	int64	Copy of device dependent \$QIO parameter p4. The low order 32-bits of this cell remain accessible via irp\$l_qio_p4.
irp\$q_qio_p5	int64	Copy of device dependent \$QIO parameter p5. The low order 32-bits of this cell remain accessible via irp\$l_qio_p5.
irp\$q_qio_p6	int64	Copy of device dependent \$QIO parameter p6. The low order 32-bits of this cell remain accessible via irp\$l_qio_p6.

A.9 I/O Request Packet Extension (IRPE)

This section describes the additions and changes to cells in the I/O Request Packet Extension (IRPE) structure. An IRPE structure can contain additional driver-specific information that needs to be associated with an IRP. It can also be used to manage additional buffers that are locked down for direct I/O.

Data Structure Changes

A.9 I/O Request Packet Extension (IRPE)

If the IRP\$M_EXTEND bit is set in irp\$l_sts then the irp\$l_extend cell contains a pointer to an associated IRPE structure. Similarly, if the IRPE\$M_EXTEND bit is set in the irpe\$l_sts cell, then the irpe\$l_extend cell contains a pointer to another IRPE. In general, if there is an IRPE cell with the name irpe\$X and an IRP cell with the name irp\$X, then the cells must be at the same offsets such that the IRP and the IRPE can be used interchangeably in contexts that depend only on these common cells.

Currently, a single IRPE structure can be used to keep track of two separate regions of locked down pages. The new IRPE structure can only manage a single region of locked down pages and contains a single fixed-size primary DIOBM structure for that purpose (see Table A-10).

Table A-10 IRPE Changes

Field	Type	Comments
irpe\$b_rmod	unsigned char	Requestor's access mode. This corresponds to the irp\$b_rmod cell. The space for this IRPE cell was reserved but the cell was not previously formally defined. The addition of this cell facilitates the usage of an IRPE with the EXE_STDSREADLOCK routines because the irpe\$b_rmod cell is one of the required implicit inputs.
irpe\$l_oboff	unsigned int	Original byte offset into first page for buffer locked into memory. This corresponds to the irp\$l_oboff cell that was added to the IRP on OpenVMS Alpha but was not formally defined in the IRPE. This corrects that omission.
irpe\$q_driver_p0	int64	Available for use by driver. This cell is overlaid on what was previously filler space.
irpe\$l_driver_p0	int	Available for use by driver. This cell is overlaid on the low-order 32-bits of irpe\$q_driver_p0.
irpe\$l_driver_p1	int	Available for use by driver. This cell is overlaid on the high-order 32-bits of irpe\$q_driver_p0.
irpe\$q_driver_p2	int64	Available for use by driver. This cell is overlaid on what was previously filler space.
irpe\$l_driver_p2	int	Available for use by driver. This cell is overlaid on the low-order 32-bits of irpe\$q_driver_p2.
irpe\$l_driver_p3	int	Available for use by driver. This cell is overlaid on the high-order 32-bits of irpe\$q_driver_p2.
irpe\$pq_va_pte	PTE_PQ	A 64-bit pointer to the actual PTEs that map the user buffer. If the user buffer is not in shared system space, then this PTE virtual address is only valid in the caller's process context.

(continued on next page)

Data Structure Changes

A.9 I/O Request Packet Extension (IRPE)

Table A–10 (Cont.) IRPE Changes

Field	Type	Comments
irpe\$l_svapte	PTE *	A 32-bit pointer to a copy of the PTEs that map the user buffer. If zero, then no PTEs have been locked for this request. This cell replaces the irpe\$l_svapte1 cell.
irpe\$l_svapte1	-	This cell has been removed. It is replaced by the irpe\$l_svapte cell.
irpe\$l_bcmt	unsigned int	Byte count for buffer locked into memory. This cell replaces the irpe\$l_bcmt1 cell.
irpe\$l_bcmt1	-	This cell has been removed. It is replaced by the irpe\$l_bcmt cell.
irpe\$l_boff	unsigned int	Byte offset into first page for buffer locked into memory. This cell replaces the irpe\$l_boff1 cell.
irpe\$l_boff1	-	This cell has been removed. It is replaced by the irpe\$l_boff cell.
irpe\$ <i>r</i> _diobm	DIOBM	Embedded fixed-size primary "direct I/O buffer map" structure. This embedded DIOBM structure is valid if and only if the irpe\$l_svapte cell contains a non-zero value. See Section A.6 for a complete description of the DIOBM structure.
irpe\$l_svapte2	-	This cell has been removed. It was used to contain a pointer to the first PTE for a second buffer that was locked into memory. If zero, then there was no second buffer.
irpe\$l_bcmt2	-	This cell has been removed. It was used for the byte count for the second buffer locked into memory.
irpe\$l_boff2	-	This cell has been removed. It was used for the byte offset for the second buffer locked into memory.

A.10 Process Header (PHD)

This section describes the I/O-specific additions to cells in Process Header (PHD) structure (see Table A–11).

Table A–11 PHD Structure Changes

Field	Type	Comments
phd\$l_iorefc	uint32	Number of reasons to keep the PHD resident due to groups of pages locked for direct I/O. This count is incremented by MMG_STDSIOLOCK_BUF and decremented by MMG_STDSIOUNLOCK_BUF. On the zero-to-one transition of this cell, the slot reference count for the process in the PHV\$GL_REFCBAS_LW vector is incremented. On the one-to-zero transition of this cell, the slot reference count for the process in the PHV\$GL_REFCBAS_LW vector is decremented.

A.11 SCSI-2 Diagnose Buffer (S2DGB)

For information about S2DGB 64-bit addressing support, see the *OpenVMS Alpha Guide to 64-Bit Addressing and VLM Features*².

A.12 VMS Communications Request Packet (VCRP)

The VCRP structure is the VMS Communications Request Packet that is used by the OpenVMS LAN driver VMS Communications Interface (VCI). A VCRP is used to transfer data between an upper- and lower-level VCM.

The VCRP is designed so that it can be used as an ACB by an upper-level VCM. Therefore, the VCRP has been enhanced such that it can be used either as an ACB or ACB64 structure by an upper-level VCM. This allows upper-level VCMs the flexibility of providing 64-bit AST support at some time in the future without requiring another VCRP change and the forced recompilation of all VCMs (see Table A–12).

Table A–12 VCRP Structure Changes

Field	Type	Comments
vcrp\$v_acb_flags_valid	bit	This is a new bit in the vcrp\$b_rmod cell that corresponds to the acb\$v_flags_valid bit. This bit is available for the exclusive use of upper-level VCMs.
vcrp\$l_acb64x_offset	int	Offset to the ACB64X structure embedded in this VCRP. This cell corresponds to the acb\$l_acb64x cell and is overlaid on vcrp\$l_ast. This cell is available for the exclusive use of upper-level VCMs.

(continued on next page)

² This manual has been archived but is available on the OpenVMS Documentation CD-ROM. This information has also been included in the *OpenVMS Programming Concepts Manual, Volume I*.

Data Structure Changes

A.12 VMS Communications Request Packet (VCRP)

Table A–12 (Cont.) VCRP Structure Changes

Field	Type	Comments
vcrp\$l_acb_flags	unsigned int	This cell corresponds to the acb\$l_flags cell and is overlaid on the first longword of the existing fork block filler space in the VCRP. This cell is available for the exclusive use of upper-level VCMs.
vcrp\$l_thread_id	int	This cell corresponds to the acb\$l_thread_pid cell and is on the second longword of the existing fork block filler space in the VCRP. Reserved for use by the Kernel Threads project.
vcrp\$pq_acb64_ast	VOID_FUNC_PQ	This cell corresponds to the acb64\$pq_ast cell. This cell is available for the exclusive use of upper-level VCMs.
vcrp\$q_acb64_astprm	int64	This cell corresponds to the acb64\$q_astprm cell. This cell is available for the exclusive use of upper-level VCMs.
vcrp\$q_user_thread_id	uint64	Unique user thread identifier. Corresponds to the acb64\$q_user_thread_id cell. This cell is available for the exclusive use of upper-level VCMs.
vcrp\$pq_buffer_addr64	VOID_PQ	64-bit buffer address. This cell is available for use by upper-level VCMs only. Note that this cell does not replace the vcrp\$l_buffer_address cell which continues to be used by lower-level VCMs.
vcrp\$sr_diobm	DIOBM	Embedded fixed-size primary "direct I/O buffer map" structure. This DIOBM structure is available for use by upper-level VCMs that need to lock down a buffer and provide a value for the vcrp\$l_svapte cell.
vcrp\$t_internal_stack	char[220]	This existing internal stack area of 92 bytes has been increased to 220 bytes to reflect the increased size of a DCBE. SYSPEDRIVER requires that it can place a DCBE within this stack area. This space is available for the exclusive use of upper-level VCMs.

I/O Support Routine Changes

This appendix contains detailed descriptions of the changes to I/O support routines and the new I/O support routines that are available to enhance device drivers to support 64-bit addresses.

The routines are listed in alphabetical order.

B.1 ACP_STD\$READBLK and ACP_STD\$WRITEBLK

The routines ACP_STD\$READBLK and ACP_STD\$WRITEBLK are upper-level FDT routines, so their interfaces remain unchanged:

```
int acp_std$readblk (IRP *irp, PCB *pcb, UCB *ucb, CCB *ccb)
int acp_std$writeblk (IRP *irp, PCB *pcb, UCB *ucb, CCB *ccb)
```

These routines obtain the address of the caller's buffer from `irp->irp$l_qio_p1`. These routines have been modified to obtain the full 64-bit buffer address from `irp->irp$q_qio_p1` and pass it to EXE_STD\$READLOCK or EXE_STD\$WRITELOCK. Note, however, that the buffer size remains a longword and is obtained from `irp->irp$l_qio_p2` without checking the upper 32-bits.

B.2 EXE_STD\$ALLOC_BUFIO_32, EXE_STD\$ALLOC_BUFIO_64

Routines EXE_STD\$ALLOC_BUFIO_32 and EXE_STD\$ALLOC_BUFIO_64 are new routines that device drivers can use to allocate and initialize simple buffered I/O (BUFIO) packets. The appropriate IRP and BUFIO header cells are initialized but it is up to the caller to copy any data into the packet.

The interfaces for these routines are:

```
int exe_std$alloc_bufio_32 (IRP *irp, PCB *pcb, void *uva, int pktsiz)
int exe_std$alloc_bufio_64 (IRP *irp, PCB *pcb, VOID_PQ uva, int pktsiz)
```

Table B-1 summarizes the use of the arguments.

Table B-1 EXE_STD\$ALLOC_BUFIO_32, EXE_STD\$ALLOC_BUFIO_64 Arguments

Argument	Type	Access	Description
irp	IRP *	Input	Pointer to the current IRP.
pcb	PCB *	Input	Pointer to the process PCB.
uva	VOID_PQ	Input	User virtual address, EXE_STD\$ALLOC_BUFIO_64
	void *	Input	User virtual address, EXE_STD\$ALLOC_BUFIO_32

(continued on next page)

I/O Support Routine Changes

B.2 EXE_STD\$ALLOC_BUFIO_32, EXE_STD\$ALLOC_BUFIO_64

Table B–1 (Cont.) EXE_STD\$ALLOC_BUFIO_32, EXE_STD\$ALLOC_BUFIO_64 Arguments

Argument	Type	Access	Description
pktsiz	int	Input	Required size of the packet including the packet header.

These routines use the EXE_STD\$DEBIT_BYTCNT_ALO routine to allocate the packet and charge the process for the required BYTCNT quota. Any failure status from this routine is returned to the caller.

Table B–2 lists all the implicit outputs that are valid on successful return from these routines.

Table B–2 EXE_STD\$ALLOC_BUFIO_32, EXE_STD\$ALLOC_BUFIO_64 Implicit Outputs

Field	Value on Successful Completion
irp\$ps_bufio_pkt	Pointer to the allocated BUFIO packet.
irp\$l_boff	Number of charged bytes and size of allocated packet.
bufio\$ps_pktdata	Pointer to the packet data region in the allocated BUFIO packet.
bufio\$ps_uva32	For EXE_STD\$ALLOC_BUFIO_32, value of uva. For EXE_STD\$ALLOC_BUFIO_64, BUFIOSK_64.
bufio\$w_size	Size of allocated packet.
bufio\$b_type	DYN\$C_BUFIO.
bufio\$spq_uva64	For EXE_STD\$ALLOC_BUFIO_64, value of uva.

B.3 EXE_STD\$ALLOC_DIAGBUF

Routine EXE_STD\$ALLOC_DIAGBUF is a new routine that allocates either a 32-bit or 64-bit diagnostic buffer packet and initializes the diagnostic buffer packet header. Diagnostic buffer packets use the same layout as BUFIO packets. This routine initializes the appropriate IRP and BUFIO header cells in the diagnostic buffer packet header but it is up to the caller to copy any data into the packet.

The allocation of a 32-bit or 64-bit format diagnostic buffer packet is controlled by a flag bit in the packet size value that is passed to this routine. This allows callers to simply pass in the value of the ddt\$w_diagbuf cell directly to this routine.

The interface for this routine is:

```
int exe_std$alloc_diagbuf (IRP *irp, VOID_PQ *uva, int pktsiz)
```

Table B–3 summarizes the use of the arguments.

Table B-3 EXE_STD\$ALLOC_DIAGBUF Arguments

Argument	Type	Access	Description
irp	IRP *	Input	Pointer to the current IRP.
uva	VOID_PQ	Input	User virtual address.
pktsiz	int	Input	The low-order 15-bits of this parameter specify the required size of the packet including the diagnostic packet header. If bit-16 (DDTSM_DIAGBUF64) is set a 64-bit diagnostic buffer packet is allocated. Otherwise a 32-bit diagnostic buffer packet is allocated.

This routine uses the EXE_STD\$ALLOCCBUF routine to allocate the packet. Any failure status from this routine is returned to the caller of EXE_STD\$ALLOC_DIAGBUF. Note that the EXE_STD\$ALLOCCBUF routine may put the process in a resource wait state and there is no additional process quota charge for a diagnostic buffer packet.

Table B-4 lists all the implicit outputs that are valid on successful return from this routine.

Table B-4 EXE_STD\$ALLOC_DIAGBUF Implicit Outputs

Field	Value on Successful Completion
irp\$l_diagbuf	Pointer to the allocated diagnostic buffer packet.
irp\$l_sts	Status flag IRP\$M_DIAGBUF is set to indicate that the IRP has an associated diagnostic buffer packet.
bufio\$ps_pktdata	Pointer to the packet data region in the allocated diagnostic BUFIO packet.
bufio\$ps_uva32	If DDTSM_DIAGBUF64 clear, value of uva. If DDTSM_DIAGBUF64 set, BUFIOSK_64.
bufio\$w_size	Size of allocated diagnostic buffer packet.
bufio\$b_type	DYN\$C_BUFIO
bufio\$pq_uva64	If DDTSM_DIAGBUF64 set, value of uva.

B.4 EXE_STD\$LOCK_ERR_CLEANUP

Routine EXE_STD\$LOCK_ERR_CLEANUP is a new routine. This routine unlocks any previously locked down buffers that are associated with the specified IRP or any IRPEs that are attached to it. Additionally, all the attached IRPEs are deallocated.

This routine is designed to be called in a driver-supplied error callback routine that is called if any error is encountered in the EXE_STD\$READLOCK, EXE_STD\$WRITELOCK, or EXE_STD\$MODIFY_LOCK routines.

The interface for this routine is:

```
void exe_std$lock_err_cleanup (IRP *irp)
```

I/O Support Routine Changes

B.4 EXE_STD\$LOCK_ERR_CLEANUP

Table B-5 summarizes the use of the arguments.

Table B-5 EXE_STD\$LOCK_ERR_CLEANUP Arguments

Argument	Type	Access	Description
irp	IRP *	Input	Pointer to the current IRP.

Table B-6 lists all the implicit inputs and outputs that are used by this routine.

Table B-6 EXE_STD\$LOCK_ERR_CLEANUP Implicit Inputs and Outputs

Implicit Inputs from the IRP	
Field	Use
irp\$l_svapte	If non-zero, points to the first PTE for a set of pages that will be unlocked.
irp\$l_bcmt	Used only if irp\$l_svapte is non-zero to calculate number of pages that will be unlocked.
irp\$l_boff	Used only if irp\$l_svapte is non-zero to calculate number of pages that will be unlocked.
irp\$sv_extend	If set, the IRPE pointed to by irp\$l_extend will be processed.
irp\$l_extend	Used only if irp\$sv_extend is set to find the first IRPE.
Implicit Inputs from Each IRPE	
Field	Use
irpe\$l_svapte	If non-zero, points to the first PTE for a set of pages that will be unlocked.
irpe\$l_bcmt	Used only if irpe\$l_svapte is non-zero to calculate number of pages that will be unlocked.
irpe\$l_boff	Used only if irpe\$l_svapte is non-zero to calculate number of pages that will be unlocked.
irpe\$sv_extend	If set, the IRPE pointed to by irpe\$l_extend will be processed.
irpe\$l_extend	Used only if irpe\$sv_extend is set to find the next IRPE.
Implicit Outputs in the IRP	
Field	Value Written
irp\$l_svapte	Cleared to indicate no locked pages.
irp\$sv_extend	Cleared to indicate no attached IRPEs.

B.5 EXE_STD\$MODIFY, EXE_STD\$READ, EXE_STD\$WRITE

The routines EXE_STD\$MODIFY, EXE_STD\$READ, and EXE_STD\$WRITE are upper-level FDT routines, so their interfaces remain unchanged:

```
int exe_std$modify (IRP *irp, PCB *pcb, UCB *ucb, CCB *ccb)
int exe_std$read  (IRP *irp, PCB *pcb, UCB *ucb, CCB *ccb)
int exe_std$write (IRP *irp, PCB *pcb, UCB *ucb, CCB *ccb)
```

I/O Support Routine Changes

B.5 EXE_STD\$MODIFY, EXE_STD\$READ, EXE_STD\$WRITE

These routines obtain the address of the caller's buffer from `irp->irp$l_qio_p1`. These routines have been modified to obtain the full 64-bit buffer address from `irp->irp$q_qio_p1` and pass it to `EXE_STD$READLOCK` or `EXE_STD$WRITELOCK`. Note, however, that the buffer size remains a longword and is obtained from `irp->irp$l_qio_p2` without checking the upper 32-bits.

B.6 EXE_STD\$MODIFYLOCK, EXE_STD\$READLOCK, EXE_STD\$WRITELOCK

The routines `EXE_STD$MODIFYLOCK`, `EXE_STD$READLOCK`, and `EXE_STD$WRITELOCK` are FDT support routines that:

- Probe the accessibility of a specified buffer by the mode contained in `irp->irp$b_mode`
- Lock the buffer into memory if the probe succeeds
- Return the address of the first PTE that maps the buffer in `irp->irp$l_svapte`

If an error is encountered, an optional error callback routine is invoked and the I/O request is aborted. If the entire buffer is not resident then the I/O request is backed out and a special status is returned to request a pagefault of the needed page.

In releases prior to OpenVMS Alpha Version 7.0, the interfaces for these routines were:

```
int exe_std$modifylock (IRP *irp, PCB *pcb, UCB *ucb, CCB *ccb,
                       void *buf, int bufsiz, void (*err_rout)(...))
int exe_std$readlock   (IRP *irp, PCB *pcb, UCB *ucb, CCB *ccb,
                       void *buf, int bufsiz, void (*err_rout)(...))
int exe_std$writelock  (IRP *irp, PCB *pcb, UCB *ucb, CCB *ccb,
                       void *buf, int bufsiz, void (*err_rout)(...))
```

The new interfaces for these routines are:

```
int exe_std$modifylock (IRP *irp, PCB *pcb, UCB *ucb, CCB *ccb,
                       VOID_PQ buf, int bufsiz [, void (*err_rout)(...)] )
int exe_std$readlock   (IRP *irp, PCB *pcb, UCB *ucb, CCB *ccb,
                       VOID_PQ buf, int bufsiz [, void (*err_rout)(...)] )
int exe_std$writelock  (IRP *irp, PCB *pcb, UCB *ucb, CCB *ccb,
                       VOID_PQ buf, int bufsiz [, void (*err_rout)(...)] )
```

There are two differences in the new OpenVMS Alpha Version 7.0 interfaces:

1. These functions now use the full 64-bits of the buffer address `buf` that is passed by value. Previously, the buffer address was a 32-bit value that was sign-extended into a 64-bit parameter value.
2. It is possible to omit the `err_rout` parameter. Currently, one can pass in the value 0 to specify that there is no error routine.

The new interface supports either method of specifying that there is no error routine. Because many callers do not require an error routine, this allows them to call these routines more efficiently with six parameters.

Both of these interface changes are upwardly compatible.

I/O Support Routine Changes

B.6 EXE_STD\$MODIFYLOCK, EXE_STD\$READLOCK, EXE_STD\$WRITELOCK

B.6.1 CALL_xLOCK and CALL_xLOCK_ERR Macros

There are six MACRO-32 macros that facilitate the use of the routines described in Section B.6 by code that was originally written to use the JSB-interface counterparts for these routines. These macros have implicit register inputs and outputs that correspond to the register inputs and outputs of the JSB-interface routines.

The CALL_MODIFYLOCK, CALL_READLOCK, and CALL_WRITELOCK macros have been modified to pass the full 64-bits of R0 as the buffer address and to omit the optional error routine parameter instead of passing the value 0.

The CALL_MODIFYLOCK_ERR, CALL_READLOCK_ERR, and CALL_WRITELOCK_ERR macros have been modified to pass the full 64-bits of R0 as the buffer address.

This is an upwardly compatible change to the implementation of these macros. This change is transparent to users prior to OpenVMS Alpha Version 7.0, because R0 currently contains the 32-bit buffer address sign-extended to 64-bits.

B.7 EXE_STD\$READCHK and EXE_STD\$WRITECHK

The routines EXE_STD\$READCHK and EXE_STD\$WRITECHK probe the accessibility of a specified buffer by the mode contained in `irp->irp$b_mode`.

In releases prior to OpenVMS Alpha Version 7.0, the interfaces for these routines were:

```
int exe_std$readchk (IRP *irp, PCB *pcb, UCB *ucb, void *buf, int bufsiz)
int exe_std$writechk (IRP *irp, PCB *pcb, UCB *ucb, void *buf, int bufsiz)
```

As of OpenVMS Alpha Version 7.0, the new interfaces for these routines are:

```
int exe_std$readchk (IRP *irp, PCB *pcb, UCB *ucb, VOID_PQ buf, int bufsiz)
int exe_std$writechk (IRP *irp, PCB *pcb, UCB *ucb, VOID_PQ buf, int bufsiz)
```

The only difference in the new interface is that these functions now use the full 64-bits of the buffer address `buf` that is passed by value. Previously, the buffer address was a 32-bit value sign-extended into a 64-bit parameter value. Thus, this is an upward compatible change to the interface.

B.7.1 CALL_xCHK and CALL_xCHKR Macros

The CALL_READCHK, CALL_READCHKR, CALL_WRITECHK, and CALL_WRITECHKR MACRO-32 macros have been modified to pass the full 64-bits of the buffer address in a similar fashion as described in Section B.6.1.

B.8 EXE_STD\$SETCHAR and EXE_STD\$SETMODE

The routines EXE_STD\$SETCHAR and EXE_STD\$SETMODE are upper-level FDT routines, thus their interfaces remain unchanged:

```
int exe_std$setchar (IRP *irp, PCB *pcb, UCB *ucb, CCB *ccb)
int exe_std$setmode (IRP *irp, PCB *pcb, UCB *ucb, CCB *ccb)
```

Both of these routines use the local routine CHECK_SET to obtain and validate a pointer to the caller's buffer from `irp->irp$l_qio_p1`. The routine CHECK_SET has been modified to obtain the full 64-bit buffer address from `irp->irp$q_qio_p1`. Routines EXE_STD\$SETCHAR and EXE_STD\$SETMODE has been modified to use the 64-bit pointer returned by CHECK_SET when loading the UCB characteristics from the caller's buffer.

B.9 IOC_STD\$CREATE_DIOBM

Routine IOC_STD\$CREATE_DIOBM is a new routine that is used to derive a 32-bit system virtual address for a specific number of PTEs that are pointed to by a 64-bit process virtual address. This routine allocates a "primary" DIOBM structure of sufficient size for its needs and returns a pointer to it. When the derived 32-bit system virtual address is no longer required the DIOBM must be released by calling the IOC_STD\$RELEASE_DIOBM routine.

The algorithm used by this routine is very similar to the one used by IOC_STD\$FILL_DIOBM as described in Section B.10. The significant difference is that IOC_STD\$CREATE_DIOBM allocates a sufficiently sized primary DIOBM structure for its needs and does not depend on a preallocated fixed-size DIOBM. This routine is designed for previous users of the MMG\$IOLOCK routine that do not have an embedded DIOBM to work with, but can maintain a single pointer to the external DIOBM structure that is returned by IOC_STD\$CREATE_DIOBM.

The interface for IOC_STD\$CREATE_DIOBM is:

```
int ioc_std$create_diobm (const PTE_PQ va_pte, const uint32 pte_count,
                        const uint32 flags,
                        PTE **svapte_p, DIOBM **diobm_p)
```

Table B-7 summarizes the use of the arguments.

Table B-7 IOC_STD\$CREATE_DIOBM Arguments

Argument	Type	Access	Description
va_pte	PTE_PQ	Input	A 64-bit pointer to the first PTE that maps the user buffer.
pte_count	uint32	Input	Number of PTEs that are required to map the entire buffer.
svapte_p	PTE **	Output	Pointer to a 32-bit PTE address that is returned. The returned address is always a 32-bit system virtual address.
flags	uint32	Input	Option flags. The following bit mask values can be set: DIOBMSM_NORESWAIT - Disable resource wait. All other option bits must be zero.
diobm_p	DIOBM **	Output	Pointer to DIOBM address that is returned.

This routine requires system resources, nonpaged pool and possibly SPTes. If there are insufficient resources, this routine will, by default, place the process (kernel thread) in a kernel mode wait state for nonpaged pool and try again until it succeeds. In this case, the return value of this routine is always SSS_NORMAL because it will not return until it can do so successfully.

However, the caller can inhibit this resource wait by setting the DIOBMSM_NORESWAIT option in the flags parameter. When this is done an error status is returned to the caller if there are insufficient system resources. This capability is intended to be used in contexts where either a resource wait in kernel mode is not acceptable or the caller can readily put the process into a wait state in the requestor's mode.

This routine must be called in process context and assumes that it was called at IPL 2, or minimally, that it can lower IPL to 2.

I/O Support Routine Changes

B.9 IOC_STD\$CREATE_DIOBM

The use of the DIOBM structure by this routine is described in detail in Appendix A.

This routine is coded in C and is contained in the new DIOBM.C module.

B.10 IOC_STD\$FILL_DIOBM

Routine IOC_STD\$FILL_DIOBM is a new routine that is used to derive a 32-bit system virtual address for a specific number of PTEs that are pointed to by a 64-bit process virtual address. This routine employs a previously allocated or embedded "primary" DIOBM structure that must be supplied as one of its inputs. When the derived 32-bit system virtual address is no longer required, the DIOBM must be released by calling the IOC_STD\$RELEASE_DIOBM routine.

This routine derives a 32-bit system virtual address for the PTEs using one of the following methods:

1. If the PTEs are in the region of the page table space that maps S0/S1 space, a 32-bit PTE address using the SPT window is returned.
2. If less than or equal to DIOBM\$K_PTECNT_FIX PTEs are required, the PTEs are copied into the PTE vector in the DIOBM and the 32-bit system virtual address of the PTE vector in the DIOBM is returned.
3. If more than DIOBM\$K_PTECNT_FIX and less than or equal to ioc\$gl_diobm_ptecnt_max PTEs are required, a secondary DIOBM is allocated, the PTEs are copied into the PTE vector in the secondary DIOBM, and the 32-bit system virtual address of the PTE vector in the secondary DIOBM is returned.
4. If more than ioc\$gl_diobm_ptecnt_max PTEs are required, a temporary PTE window in S0/S1 space is created that maps the necessary process level-3 page table pages. These level-3 page table pages are locked into memory and the 32-bit S0/S1 address of the PTEs through the PTE window is returned.

The interface for IOC_STD\$FILL_DIOBM is:

```
int ioc_std$fill_diobm (DIOBM *const diobm, const PTE_PQ va_pte,  
                      const uint32 pte_count, const uint32 flags,  
                      PTE **svapte_p)
```

Table B-8 summarizes the use of the arguments.

Table B-8 IOC_STD\$FILL_DIOBM Arguments

Argument	Type	Access	Description
diobm	DIOBM *	Input	Pointer to a previously allocated but unused or uninitialized DIOBM structure.
va_pte	PTE_PQ	Input	A 64-bit pointer to the first PTE that maps the user buffer.
pte_count	uint32	Input	Number of PTEs that are required to map the entire buffer.

(continued on next page)

Table B-8 (Cont.) IOC_STD\$FILL_DIOBM Arguments

Argument	Type	Access	Description
flags	uint32	Input	Option flags. The following bit mask values can be set: DIOBMSM_NORESWAIT - Disable resource wait. All other option bits must be zero.
svapte_p	PTE **	Output	Pointer to a 32-bit PTE address that is returned. The returned address is always a 32-bit system virtual address.

This routine may require system resources, either nonpaged pool or SPTEs, depending on the number of PTEs that are required to map the buffer. If there are insufficient resources this routine will, by default, place the process (kernel thread) in a kernel mode wait state for nonpaged pool and try again until it succeeds. In this case, the return value of this routine is always SSS_NORMAL because it will not return until it can do so successfully.

However, the caller can inhibit this resource wait by setting the DIOBMSM_NORESWAIT option in the flags parameter. When this is done, an error status is returned to the caller if there are insufficient system resources. This capability is intended to be used in contexts where either a resource wait in kernel mode is not acceptable or the caller can readily put the process into a wait state in the requestor's mode.

This routine must be called in process context and assumes that it was called at IPL 2, or minimally that it can lower IPL to 2.

The use of the DIOBM structure by this routine is described in detail in Appendix A. The normal version of the IOC_STD\$FILL_DIOBM routine makes no assumptions about the contents of the input DIOBM structure. In contrast, the full checking version of this routine in the IO_ROUTINES_MON.EXE execlt performs some initial validation and declares an INCONSTATE bugcheck should this check fail.

B.11 IOC_STD\$PTETOPFN

The routine IOC_STD\$PTETOPFN allows drivers or other components to obtain the PFN for a page that has been previously locked into memory but the valid bit in its PTE is currently clear. This routine handles transition PTEs and PTEs that have reverted into GPTX format.

In releases prior to OpenVMS Alpha Version 7.0, the interface for this routine was:

```
int ioc_std$ptetopfn (PTE *pte);
```

The new interface for this routine is:

```
int ioc_std$ptetopfn (PTE_PQ pte);
```

The first interface difference is that IOC_STD\$PTETOPFN uses the full 64-bits of the caller's PTE address that is passed by value. The second interface difference is not apparent from the above function prototype. The IOC_STD\$PTETOPFN routine has been enhanced to handle the case where the pte\$v_valid bit is set in the PTE. Therefore, drivers can use this routine without first checking the valid bit.

I/O Support Routine Changes

B.11 IOC_STD\$PTETOPFN

Both of these are upwardly compatible changes to the interface.

B.12 IOC_STD\$RELEASE_DIOBM

Routine IOC_STD\$RELEASE_DIOBM is a new routine that is used to release the PTE mapping resources that were set up by a prior call to either the IOC_STD\$CREATE_DIOBM or IOC_STD\$FILL_DIOBM routines.

The interface for IOC_STD\$RELEASE_DIOBM is:

```
int ioc_std$release_diobm (DIOBM *const diobm)
```

Table B-9 summarizes the use of the arguments.

Table B-9 IOC_STD\$RELEASE_DIOBM Arguments

Argument	Type	Access	Description
diobm	DIOBM *	Input	Pointer to an active primary DIOBM.

This routine deallocates any secondary DIOBM that is connected to the primary DIOBM. If this primary DIOBM has a PTE window, the resources used for the window are deallocated. If the primary DIOBM was allocated by IOC_STD\$CREATE_DIOBM, the primary DIOBM is deallocated as well. The use of the DIOBM structure by this routine is described in detail in Appendix A.

The returned value of this routine is always SSS_NORMAL.

This routine does not depend on process context. However, the IPL and spinlocks of the caller must allow this routine to acquire and restore the MMG spinlock.

This routine is coded in C and is contained in the new DIOBM.C module.

B.13 IOC_STD\$SIMREQCOM, IOC\$SIMREQCOM

The routine IOC_STD\$SIMREQCOM allows drivers or other components to complete an I/O that does not have a normal IRP associated with it. Because this routine does not have an IRP, the necessary information to signal an I/O completion is passed directly in separate parameters. For example, the user's IOSB address, the event flag value, a pointer to an ACB, and the caller's access mode are among the parameters.

In releases prior to OpenVMS Alpha Version 7.0, the interface for this routine was:

```
int ioc_std$simreqcom (int32 iosb[2], int pri, int efn, int32 iost[2],  
                     ACB *acb, int acmode);
```

The new interface for this routine is:

```
int ioc_std$simreqcom (VOID_PQ iosb_p, int pri, int efn, int32 iost[2],  
                     ACB *acb, int acmode);
```

The first interface difference is that IOC_STD\$SIMREQCOM uses the full 64-bits of the caller's IOSB address `iosb_p` that is passed by value. The second interface difference is not apparent from the above function prototype. The IOC_STD\$SIMREQCOM routine has been enhanced to accept either a pointer to an ACB64 or an ACB structure.

Both of these are upwardly compatible changes to the interface.

B.13.1 CALL_SIMREQCOM Macro

The CALL_SIMREQCOM MACRO-32 macro facilitates the use of the IOC_STD\$SIMREQCOM routine by code that was originally written to use the JSB-interface counterpart IOC\$SIMREQCOM. The CALL_SIMREQCOM macro has implicit register inputs that correspond to the register inputs of the JSB-interface for the IOC\$SIMREQCOM routine.

Because this macro uses registers for its inputs, it can be altered to use the full 64-bit value of the caller's IOSB address which is passed in register R1.

B.13.2 IOC\$SIMREQCOM

The IOC\$SIMREQCOM routine is simply a JSB-to-CALL jacket routine around IOC_STD\$SIMREQCOM. Because it is implemented through the use of the CALL_SIMREQCOM macro, IOC\$SIMREQCOM transparently supports a 64-bit caller's IOSB address in the R1 parameter. Similarly, this routine allows R5 to point to either an ACB or an ACB64 structure.

B.14 IOC_STD\$SVAPTE_IN_BUF

Routine IOC_STD\$SVAPTE_IN_BUF is a new routine that is used to calculate a 32-bit PTE address for a virtual address within a buffer that has been previously locked for this IRP and for which a 32-bit PTE address has been derived.

It is the caller's responsibility to ensure that the virtual address is a legal address within a buffer that has been locked into memory prior to calling this routine and that a 32-bit PTE address has been derived for this buffer. The IOC_STD\$SVAPTE_IN_BUF routine may declare a bugcheck if either of these conditions have not been met.

The interface for IOC_STD\$SVAPTE_IN_BUF is:

```
int ioc_std$svapte_in_buf (IRP *irp, VOID_PQ va, PTE **svapte_p)
```

Table B-10 summarizes the use of the arguments.

Table B-10 IOC_STD\$SVAPTE_IN_BUF Arguments

Argument	Type	Access	Description
irp	IRP *	Input	Pointer to the current IRP.
va	VOID_PQ	Input	Virtual address within the buffer that was locked for this IRP.
svapte_p	PTE **	Output	Pointer to a 32-bit PTE address that is returned. The returned address is a 32-bit system virtual address that is derived based on the values in irp\$I_svapte and irp\$q_io_p1.

Table B-11 lists all the implicit inputs that are used by this routine.

I/O Support Routine Changes

B.14 IOC_STD\$SVAPTE_IN_BUF

Table B–11 IOC_STD\$SVAPTE_IN_BUF Implicit Inputs

Field	Use
irpSq_qio_p1	Virtual address of the start of the buffer that has been previously locked into memory for this IRP.
irpSl_svapte	32-bit PTE address for the PTEs that map the buffer.

The returned value of this routine is always SSS_NORMAL.

This routine is coded in C and is contained in the new SVAPTE2.C module.

B.15 IOC_STD\$VA_TO_PA

Routine IOC_STD\$VA_TO_PA is a new routine that is used to derive a 64-bit physical memory address for a 64-bit virtual address. The virtual address is interpreted in the context of the current process and may be in either process-private or system space.

It is the caller's responsibility to ensure that the virtual address is a legal address and that the memory page containing the specified virtual address is locked into memory prior to calling this routine. The IOC_STD\$VA_TO_PA routine may declare a bugcheck if either of these conditions have not been met.

The interface for IOC_STD\$VA_TO_PA is:

```
VOID_PQ ioc_std$va_to_pa (VOID_PQ va, VOID_PPQ pa_p)
```

The returned value of this routine is the 64-bit physical address. Table B–12 summarizes the use of the arguments.

Table B–12 IOC_STD\$VA_TO_PA Arguments

Argument	Type	Access	Description
va	VOID_PQ	Input	A 64-bit virtual address.
pa_p	VOID_PPQ	Output	Pointer to a 64-bit physical address that is returned. This parameter is optional and may either be omitted entirely or specified as zero. The physical address is also returned as the value of the routine.

Currently, the physical address for a process virtual address can be derived by calling MMG_STD\$SVAPTECHK followed by IOC\$SVAPTE_TO_PA. However, as described in Section 2.2.3, the MMG_STD\$SVAPTECHK routine no longer accepts a P0/P1 address. The new IOC_STD\$VA_TO_PA routine provides a direct way of computing the physical address from a process virtual address.

B.16 MMG_STD\$GET_PTE_FOR_VA

Routine MMG_STD\$GET_PTE_FOR_VA is a new routine that is being added for use in the Remote SDA SYSAP within SYS\$SCS.

Routine MMG_STD\$GET_PTE_FOR_VA attempts to obtain the Level-3 PTE containing a PFN that maps the specified virtual address for a specified process. If the requested PTE cannot be accessed either because the virtual address is not mapped or a needed page table page is not currently in physical memory, an error status is returned. Additionally, if the Level-3 PTE does not contain a useable PFN, an error status is returned.

I/O Support Routine Changes B.16 MMG_STD\$GET_PTE_FOR_VA

A successful return status from this routine means that the PFN field of the returned PTE contains the physical page number for the input virtual address. Note that there are page states where the PTE contains a useable PFN but the PTE\$V_VALID bit is clear. Therefore, the PTE\$V_VALID bit in the returned PTE might be clear. Note also, that this routine returns a PTE from the Global Page Table when the slave PTE has reverted to GPTX format and the master PTE in the GPT still contains a PFN.

This routine is somewhat similar to MMG_STD\$CALC_VAPTE except that it does not assume that the virtual address is valid or that the necessary page tables are resident in memory. Because this routine does not assume the virtual address is valid, it uses the reserved system space window to traverse the specified process' page tables in a top-down fashion. It uses this method for all process-private virtual addresses even if the specified process happens to be the current process on this CPU. This allows this routine to locate the Level-3 PTE even if some of the intervening page table pages are in transition. However, for shared system space virtual addresses this routine uses the currently active page tables instead of the reserved system window to locate the corresponding Level-3 PTE. This is possible because shared system space page table pages are not pageable and have PTE\$V_VALID set if they are mapped.

This routine acquires and restores the MMG spinlock. This routine declares a bugcheck if the reserved system space window is already in use. This routine releases and invalidates the window before returning.

The interface for MMG_STD\$GET_PTE_FOR_VA is:

```
int mmg_std$get_pte_for_va (VOID_PQ const va, PHD *const phd, PTE_PQ pte_p)
```

Table B-13 summarizes the use of the arguments.

Table B-13 MMG_STD\$GET_PTE_FOR_VA Arguments

Argument	Type	Access	Description
va	VOID_PQ	Input	A 64-bit virtual address.
phd	PHD *	Input	Pointer to the PHD for the desired process address space. If zero, the current process on the current CPU is assumed. This parameter is not used, and may be zero, if the virtual address is in shared system space.
pte_p	PTE_PQ	Output	Address of Level-3 PTE value that is returned. A PTE value is returned only if the routine returns a successful condition value.

The returned value of this routine is a system condition value:

SSS_NORMAL	The PTE that maps the specified virtual address in the address space of the specified process contains a physical page number and was successfully returned.
SSS_ACCVIO	The PTE that maps the specified virtual address in the address space of the specified process could not be obtained, that is, the specified virtual address is not mapped or one of the necessary page table pages is not currently resident, or the level-3 PTE did not contain a physical page number.

I/O Support Routine Changes

B.17 MMG_STD\$IOLock, MMG\$IOLock, MMG_STD\$IOLock_BUF

B.17 MMG_STD\$IOLock, MMG\$IOLock, MMG_STD\$IOLock_BUF

The interface for the MMG_STD\$IOLock routine is:

```
int mmg_std$iolock (void *buf, int bufsiz, int is_read, PCB *pcb, void **svapte_p)
```

This routine returns a 32-bit address by reference (the `svapte_p` parameter) which, depending on the routine status, may specify the address of the first PTE or the address of a location in the buffer that must be faulted in.

The new version of this routine must accept a 64-bit buffer address. In addition, the new version must also return either a 64-bit PTE or buffer address. This is an incompatible interface change because this return parameter is passed by reference. Thus, MMG_STD\$IOLock has been removed and is replaced by the new MMG_STD\$IOLock_BUF routine.

The interface for MMG_STD\$IOLock_BUF is:

```
int mmg_std$iolock_buf (VOID_PQ const buf, const int bufsiz,  
                       const int is_read, PCB *const pcb,  
                       PTE_PPQ va_pte_p, VOID **fault_va_p)
```

Table B–14 summarizes the use of the arguments.

Table B–14 MMG_STD\$IOLock_BUF Arguments

Argument	Type	Access	Description
<code>buf</code>	VOID_PQ	Input	64-bit pointer to the buffer that is to be locked.
<code>bufsiz</code>	int	Input	Size of the buffer in bytes.
<code>is_read</code>	int	Input	Contains the value 0 if buffer will be only written to the device, 1 if the buffer will be only read from device, 5 if the buffer will be modified by the device.
<code>pcb</code>	PCB *	Input	Pointer to the process PCB.
<code>va_pte_p</code>	PTE_PPQ	Output	Pointer to a 64-bit PTE address that is returned. If the returned value of the function is successful, then the address returned is the 64-bit virtual address of the first PTE that maps the buffer. For all other function return values, the value returned in this parameter is undefined.
<code>fault_va_p</code>	VOID_PPQ	Output	Pointer to a 64-bit address that is returned. If the returned value of the function is zero, then the address returned is the 64-bit address within the buffer that must be faulted in. For all other function return values, the value returned in this parameter is undefined.

The returned value of this routine is a system condition value or the value zero:

Success	A successful VMS condition value indicates that the buffer has been locked and that the 64-bit virtual address of the first PTE that maps the buffer has been returned using the <code>va_pte_p</code> parameter.
---------	---

B.17 MMG_STD\$IOLock, MMG\$IOLock, MMG_STD\$IOLock_BUF

0	This return value means that a page fault is required for a page in the buffer. The virtual address of the page is returned using the <code>fault_va_p</code> parameter. Any portion of the buffer that may have been locked before this condition was detected has been unlocked before returning.
Failure	Standard VMS condition value that indicates the failure.

Just like `MMG_STD$IOLock`, the `MMG_STD$IOLock_BUF` routine must be called in process context at IPL 2 and it acquires and releases the MMG spinlock.

Although the interfaces for the `MMG_STD$IOLock_BUF` and `MMG_STD$IOLock` routines are similar, there are important differences between these routines that go beyond the width of the address parameters.

1. The 32-bit address that is returned by `MMG_STD$IOLock` in the `svapte_p` parameter is valid regardless of process context. In contrast, the 64-bit address that is returned by `MMG_STD$IOLock_BUF` in the `va_pte_p` parameter may be valid only in the context of the current process. The new routines `IOC_STD$FILL_DIOBM` and `IOC_STD$CREATE_DIOBM` are designed to deal with this difference.
2. The `MMG_STD$IOLock` routine locks into memory the level-3 page tables that contain the PTEs that map the buffer as well as the buffer pages. In contrast, `MMG_STD$IOLock_BUF` only locks the buffer pages. It does not lock the level-3 page tables because it would be difficult to unlock them in the absence of process context where `MMG_STD$IUNLOCK_BUF` is called. Moreover, the mechanisms used by `IOC_STD$FILL_DIOBM` and `IOC_STD$CREATE_DIOBM` usually do not require the locking of the level-3 page tables. Only when the PTE window method is used by `IOC_STD$FILL_DIOBM` or `IOC_STD$CREATE_DIOBM` will these routines need to lock the level-3 page table pages into memory. When this case applies, the `IOC_STD$RELEASE_DIOBM` routine has enough information to unlock the level-3 page tables regardless of process context.

The existing callers of `MMG_STD$IOLock` need to be very aware of the first of these differences. The second difference is likely to be transparent to most callers.

Because the routine `MMG$IOLock` is simply a JSB-to-CALL jacket routine around `MMG_STD$IOLock`, the `MMG$IOLock` routine has also been removed.

B.17.1 CALL_IOLock Macro

The `CALL_IOLock MACRO-32` macro facilitates the use of the `MMG_STD$IOLock` routine by code that was originally written to use the JSB-interface counterpart `MMG$IOLock`. The `CALL_IOLock` macro has implicit register inputs and outputs that correspond to the register inputs and outputs of the JSB-interface for the `MMG$IOLock` routine.

Because this macro uses registers for its inputs and outputs, it can be altered to use the full 64-bit values in these registers and it can call the `MMG_STD$IOLock_BUF` routine instead of `MMG_STD$IOLock`. Nevertheless, the `CALL_IOLock` macro has been modified to generate a suppressable interface warning at compile-time, because:

- The full 64-bits of register R1 are now significant on return.
- The returned PTE address is a 64-bit process virtual address.

I/O Support Routine Changes

B.17 MMG_STD\$IOLOCK, MMG\$IOLOCK, MMG_STD\$IOLOCK_BUF

- Callers of MMG_STD\$IOLOCK_BUF are very likely to need to call the new IOC_STD\$FILL_DIOBM or IOC_STD\$CREATE_DIOBM routines.

The format of the macro call is:

```
CALL_IOLOCK [ INTERFACE_WARNING=YES|NO ]
```

By default the interface warning is enabled and generates the following warning at compile-time:

```
%AMAC-W-GENWARN, generated WARNING: 0 CALL_IOLOCK interface has changed for 64-bit
virtual addressing; set INTERFACE_WARNING=NO to disable messages.
%AMAC-W-GENWARN, generated WARNING: 0 CALL_IOLOCK uses the 64-bit buffer address
in R0
%AMAC-W-GENWARN, generated WARNING: 0 CALL_IOLOCK returns a 64-bit VA_PTE or
fault VA in R1
%AMAC-W-GENWARN, generated WARNING: 0 CALL_IOLOCK does not lock the page table pages
%AMAC-W-GENWARN, generated WARNING: 0 A call to IOC_STD$FILL_DIOBM may be required
to derive a SVAPTE
```

The compile-time warning serves to identify the existing callers of this macro. Once the invoking code has been modified, the warning can be suppressed by specifying INTERFACE_WARNING=NO.

B.18 MMG_STD\$UNLOCK, MMG\$UNLOCK, MMG_STD\$IOUNLOCK_BUF

The interface for the MMG_STD\$UNLOCK routine is:

```
void mmg_std$unlock (int npages, void *svapte)
```

The MMG\$UNLOCK routine is simply a JSB-to-CALL jacket routine around MMG_STD\$UNLOCK.

Because 32-bit PTE addresses that may point to PTE copies are sufficient for the needs of the MMG_STD\$UNLOCK routine, there is no absolute requirement to change the interface of these routines. However, it is extremely likely that all callers of MMG_STD\$UNLOCK and MMG\$UNLOCK need to use the new DIOBM structure and need to call the new routine IOC_STD\$RELEASE_DIOBM immediately after unlocking the memory buffer. Therefore, routine MMG_STD\$UNLOCK has been renamed to MMG_STD\$IOUNLOCK_BUF and the MMG\$UNLOCK routine has been removed in order to make it difficult to miss the places where this source change is needed.

The interface for MMG_STD\$IOUNLOCK_BUF is:

```
void mmg_std$iounlock_buf (const int npages, PTE_PQ const va_pte);
```

Just like MMG_STD\$UNLOCK, the MMG_STD\$IOUNLOCK_BUF routine does not depend on process context. However, the IPL and spinlocks of the caller must allow this routine to acquire and restore the MMG spinlock.

B.18.1 CALL_UNLOCK Macro

The CALL_UNLOCK MACRO-32 macro facilitates the use of the MMG_STD\$UNLOCK routine by code that was originally written to use the JSB-interface counterpart MMG\$UNLOCK. The CALL_UNLOCK macro has implicit register inputs that correspond to the register inputs and outputs of the JSB-interface for the MMG\$UNLOCK routine.

B.18 MMG_STD\$UNLOCK, MMG\$UNLOCK, MMG_STD\$IOUNLOCK_BUF

This macro has been modified to use the full 64-bits of the R3 input which contains the PTE address. The macro calls the new MMG_STD\$IOUNLOCK_BUF routine instead of MMG_STD\$UNLOCK. In addition, the CALL_UNLOCK macro has been modified to generate a suppressable interface warning at compile-time. The format of the macro call is:

```
CALL_UNLOCK    [ INTERFACE_WARNING=YES|NO ]
```

By default the interface warning is enabled and generates the following warning at compile-time:

```
%AMAC-W-GENWARN, generated WARNING: 0 CALL_UNLOCK interface has changed for 64-bit
virtual addressing; set INTERFACE_WARNING=NO to disable messages.
%AMAC-W-GENWARN, generated WARNING: 0 CALL_UNLOCK uses the 64-bit PTE address in R3
%AMAC-W-GENWARN, generated WARNING: 0 CALL_UNLOCK does not unlock the page table
pages
%AMAC-W-GENWARN, generated WARNING: 0 A call to IOC_STD$RELEASE_DIOBM may be
required to derive a SVAPTE
```

B.19 MMG_STD\$SVAPTECHK, MMG\$SVAPTECHK

The current versions of the MMG_STD\$SVAPTECHK and MMG\$SVAPTECHK routines compute a 32-bit svapte for either a process or system space address. As of OpenVMS Alpha Version 7.0, these routines are restricted to an S0/S1 system space address and no longer accept an address in P0/P1 space. The MMG_STD\$SVAPTECHK and MMG\$SVAPTECHK routines check the full 64 bits of the input address and declare a bugcheck for an input address that is not in S0/S1 space. For S0/S1 input addresses, these routines return a 32-bit system virtual address of the PTE through the SPT window.

In releases prior to OpenVMS Alpha Version 7.0, the interface for this routine was:

```
void mmg_std$svaptechk (void *va, PCB *pcb, PHD *phd, void **svapte_p);
```

The new interface for this routine is:

```
void mmg_std$svaptechk (VOID_PQ va, PCB *pcb, PHD *phd, PTE **svapte_p);
```

The majority of callers of this routine use it with an S0/S1 address and do not need to change.

C

Kernel Threads Routines and Macros

This appendix describes the new routines and macros available implementing for kernel threads.

In addition to a few new routines to convert a PID to a KTB address, the EXE\$NAM_TO_PCB routine is modified to return the KTB address in R2, which previously was a scratch register. The new routines and macros all assume the caller is executing in kernel mode.

EXE\$CVT_IPID_TO_KTB Routine

Converts an internal PID to a KTB address.

Format

```
EXE$CVT_IPID_TO_KTB ipid ,ktb ,pcb
```

Returns

OpenVMS usage	cond_value
type	longword (unsigned)
access	write only
mechanism	by value

Status indicating the success or failure of the operation.

Arguments

ipid	
OpenVMS usage	process_id
type	longword (unsigned)
access	read
mechanism	by value

This argument provides the internal PID to be converted.

ktb	
OpenVMS usage	address
type	quadword
access	write
mechanism	by reference

This argument provides the KTB address.

Kernel Threads Routines and Macros

EXE\$CVT_IPID_TO_KTB Routine

pcb
OpenVMS usage address
type quadword
access write
mechanism by reference

This argument provides the PCB address.

Description

The EXE\$CVT_IPID_TO_KTB routine converts an internal PID to a KTB address.

Return Values

SS\$NONEXPR	The process does not exist.
SS\$NOSUCHTHREAD	The process exists but the thread does not.

EXE\$CVT_EPID_TO_KTB Routine

Converts an external PID to a KTB address.

Format

EXE\$CVT_EPID_TO_KTB epid ,ktb ,pcb

Returns

OpenVMS usage cond_value
type longword (unsigned)
access write only
mechanism by value

Status indicating the success or failure of the operation.

Arguments

epid
OpenVMS usage process_id
type longword (unsigned)
access read
mechanism by value

This argument provides the external PID to be converted.

ktb
OpenVMS usage address
type quadword
access write
mechanism by reference

This argument provides the KTB address.

Kernel Threads Routines and Macros EXE\$CVT_EPID_TO_KTB Routine

pcb
OpenVMS usage address
type quadword
access write
mechanism by reference

This argument provides the PCB address.

Description

The EXE\$CVT_EPID_TO_KTB routine converts an external PID to a KTB address.

Return Values

SS\$NONEXPR	The process does not exist.
SS\$NOSUCHTHREAD	The process exists but the thread does not.

GET_CURKTB Macro

Obtains the current process or thread KTB address. Applicable to BLISS, C, and MACRO-32. The following three command formats are for BLISS, C, and MACRO-32, respectively.

Format

```
GET_CURKTB;  
GET_CURKTB(  
GET_CURKTB ktbreg , pcbreg, [preserve][test_multi=yes]
```

Arguments

ktbreg

This argument is the destination to return the KTB address. The default is R14.

pcbreg

This argument is the register containing the address of the PCB. The default is R14.

preserve

This argument is optional. The default is YES to preserve R0 and R1. Otherwise, it is NO.

test_multi

This argument is optional. The default is YES to test and validate if there is more than one KTB. If NO, it is assumed that the process is already known to be multithreaded.

Kernel Threads Routines and Macros

GET_CURKTB Macro

Description

The GET_CURKTB macro obtains the current process or thread KTB address.

CVT_IPID_TO_PCB_KTB Macro

Converts a PID to PCB and KTB addresses. Applicable to MACRO-32 only.

Format

CVT_IPID_TO_PCB_KTB ipid ,ktbreg ,pcbreg ,fail

Returns

OpenVMS usage	cond_value
type	longword (unsigned)
access	write only
mechanism	by value

Status indicating the success or failure of the operation.

Arguments

ipid

This argument provides the internal PID to be converted.

ktbreg

This argument is the destination to return the KTB address. The default is R14.

pcbreg

This argument provides the register which returns the PCB. The default is R14.

preserve

This argument is not used by this macro but is passed to CVT_IPID_TO_KTB to indicate whether to preserve R0 and R1.

fail

This argument provides the address to transfer control if the **ipid** argument is not valid. If this transfer is taken, R0 contains one of the status values in the Return Values section.

Description

The CVT_IPID_TO_PCB_KTB macro converts a PID to PCB and KTB addresses. This macro applies to MACRO-32 only.

Return Values

SS\$NONEXPR	The process does not exist.
SS\$NOSUCHTHREAD	The process exists but the thread does not.

CVT_IPID_TO_KTB Macro

Converts a PID to a KTB address. Applies to MACRO-32 only.

Format

CVT_IPID_TO_KTB ipid ,ktbreg ,pcbreg ,preserve ,fail

Returns

OpenVMS usage	cond_value
type	longword (unsigned)
access	write only
mechanism	by value

Status indicating the success or failure of the operation.

Arguments

ipid

This argument provides the internal PID to be converted.

ktbreg

This argument provides the register that returns the KTB. The default is R14.

pcbreg

This argument provides the register which holds the PCB. The default is R14.

preserve

This argument's default is YES to save R0 and R1.

fail

This argument provides the address to transfer control if the **ipid** argument is not valid. If this transfer is taken, R0 contains one of the status values in the Return Values section.

Description

The CVT_IPID_TO_KTB macro converts a PID to a KTB address. This macro applies to MACRO-32 only.

Return Values

SS\$_NONEXPR	The process does not exist.
SS\$_NOSUCHTHREAD	The process exists but the thread does not.

A

Asynchronous System Traps (ASTs), 2–11

C

CPU\$L_CURKTB field, 2–10

CTL\$AL_STACK array, 2–14

CTL\$AL_STACKLIM array, 2–14

CVT_IPID_TO_KTB Macro, C–5

CVT_IPID_TO_PCB_KTB Macro, C–4

D

Data Cells, 6–4

E

EPIDs (extended process IDs), 6–5

EXESCVT_EPID_TO_KTB Routine, C–2

EXESCVT_IPID_TO_KTB Routine, C–1

Executive stack, 6–3

Extended process IDs

See EPID

F

Floating-point registers and execution data blocks

See FREDs

FREDs (floating-point registers and execution data blocks), 2–14, 6–3

G

GET_CURKTB Macro, C–3

H

Hardware process control blocks

See HWPCBs

HWPCBs (hardware process control blocks), 6–1, 6–3

I

Image Registry facility, overview, 2–15

Images, registering for version dependencies, 2–15

Infrastructure Changes

summary, 2–1

Installation and upgrade restrictions

upgrading privileged software, 2–15

Internal PIDs

See IPIDs

IPIDs, internal PIDs, 6–6

K

Kernel stack, 6–3

Kernel thread blocks

See KTBs

Kernel thread block vector, 6–2

Kernel threads region, 6–3

KTBs (kernel thread blocks), 6–2

M

Mutex locking, 2–11

MWAIT state, 2–11

P

P0 space, 6–3

P1 space, 6–3

layout, 6–4

PCBs (process control blocks), 6–1

Per-kernel thread stacks, 6–3

PHDs (process headers), 6–1

PIDs (process identifiers), 6–5, 6–7

PIX (process index), 6–6

Privileged shareable images

creating, 5–1

definition, 5–1

Privileged software, version dependencies, 2–15

Process control blocks

See PCBs

Process header

See PHDs

Process identifiers
 See PIDs
Process index
 See PIX
Process page tables, location, 2-8
Process status bits, 6-8

R

Range checking, 6-7
Restrictions
 installation and upgrade
 upgrading privileged software, 2-15

S

Scheduling routines, 2-11
Sequence vectors, 6-7
Shareable images, privileged, 5-1
Subsystems, version ID changes, 2-15

Supervisor stack, 6-3
SYSSCREPRC system service, 6-7
SYSSGETJPI system service, 6-8
SYSSPROCESS_SCAN system service, 6-8
System services, dispatching, 2-11
System Working Set List, 2-8

T

TB invalidation, 2-12

U

User stack, 6-3

V

Version dependencies, registering images with,
 2-15